

AquaCal® Operation Manual

HEATWAVE SUPERQUIET®



Important

Read this document before operating / installing this product

For additional product manuals and operation / installation procedures, please visit www.AquaCal.com

[-----]

MODEL / SERIAL NUMBER

Table of Contents

Contacting AquaCal AutoPilot, Inc.	1
Safety Instructions	1
1 - Operation	3
1.1 Display Door	3
1.2 Energizing Heat Pump	3
1.3 Wake Up Heat Pump	3
1.4 Display Panel	3
1.4.a Buttons	4
1.4.b Display	4
1.4.c Indicator Lights	5
1.5 User Level Programming	5
1.5.a User Level Factory Defaults	5
1.5.b Selecting Celsius or Fahrenheit	6
1.5.c Setting Operating Mode	7
1.5.d Setting Thermostats	7
1.5.e User Lock Option (Enable)	8
1.5.f User Lock Option (Disable)	9
1.5.g Using Pass Code to Access Heat Pump	9
1.5.h Operating Heat Pump (With an External Controller)	10
2 - Maintenance	11
2.1 Water Chemistry	11
2.2 Cleaning Equipment	12
2.3 Clearances	13
2.4 Irrigation and Storm Run-Off	14
2.5 Water Flow Rates	14
2.6 Adjusting Water Flow Using ΔT (Delta-T)	15
2.7 Planned Maintenance	16
2.8 Winterizing	17
3 - Appendix	19
3.1 Identifying Model Specifications	19
3.2 Weights	20
3.3 Heating Recommendations	20
3.4 Cooling Recommendations	20
3.5 Available Accessories	21
4 - Troubleshooting	23
4.1 Fault Codes	23
4.2 Issues and Resolutions	26

Contacting AquaCal AutoPilot, Inc.

For further assistance, please contact the distributor or installer of this product.

If unavailable, please contact AquaCal® for a partner in your area. To better assist you, please have the heat pump model and serial number available. See "Identifying Model Specifications" on page 19.



Product Information:	
Website	www.AquaCal.com
Phone	(1) 727-823-5642
Hours	8-5 pm, Eastern M-F

Service Information:	
Website	www.AquaCal.com/request-heat-pump-service/

SAFETY INSTRUCTIONS

- For personal safety, and to avoid damage to equipment, follow all safety instructions displayed on the equipment and within this manual. Repair and service of heat pump must be performed by an authorized service center.
- Warranties may be voided if the equipment has been improperly installed, maintained or serviced.
- If service is deemed necessary, please see "Contacting AquaCal AutoPilot, Inc." on page 1.

SAFETY SIGNALS
Throughout this document, safety signals have been placed where particular attention is required.

	- Failure to heed the following will result in injury or death.
	Failure to heed the following may result in injury or death.
	Failure to heed the following may result in damage to equipment.

When installing and using your heat pump basic safety precautions must always be followed, including the following:

- | | |
|--|---|
|  | - Failure to heed the following will result in injury or death. |
|--|---|
- The heat pump utilizes high voltage and rotating equipment. Use caution when servicing.

⚠ WARNING

Failure to heed the following may result in injury or death.

- Installation and repairs must be performed by a qualified technician.
- The heat pump contains refrigerant under pressure. Repairs to the refrigerant circuit must not be attempted by untrained and / or unqualified individuals. Service must be performed only by qualified HVAC technicians. Recover refrigerant before opening the system.
- Improper water chemistry can present a serious health hazard. To avoid possible hazards, maintain pool / spa water per standards detailed in this document.
- Prolonged immersion in water warmer than normal body temperature may cause a condition known as Hyperthermia. The symptoms of Hyperthermia include unawareness of impending hazard, failure to perceive heat, failure to recognize the need to exit the spa, and unconsciousness. The use of alcohol, drugs, or medication can greatly increase the risk of fatal Hyperthermia. In addition, persons having an adverse medical history, or pregnant women, should consult a physician before using a hot tub or spa. Children and the elderly should be supervised by a responsible adult.
- Prolonged immersion in water colder than normal body temperature may cause a condition known as Hypothermia. The symptoms of Hypothermia include shivering (although as hypothermia worsens, shivering stops), clumsiness or lack of coordination, slurred speech or mumbling, confusion and poor decision-making, drowsiness or low energy, lack of concern about personal welfare, progressive loss of consciousness, weak pulse and slow or shallow breathing. In addition, persons having an adverse medical history, or pregnant women, should consult a physician before immersing in a cold body of water. Children and the elderly should be supervised by a responsible adult.

NOTICE

Failure to heed the following may result in damage to equipment.

- Maintain proper water chemistry in order to avoid damage to pump, filter, pool shell, etc.
- Water flow exceeding maximum flow rate requires a bypass. Damage due to excessive water flow will void warranty.

SAVE THESE INSTRUCTIONS

1 - Operation

1.1 Display Door

The display panel is located in a door compartment on the front of the heat pump. This compartment is designed to protect the display against harsh weather. It can also be padlocked for extra security.

- Press the **bottom** of the panel to open the display panel door.
- To close, push the display panel up. Then press the **bottom** of the panel in until a clicking noise is heard.

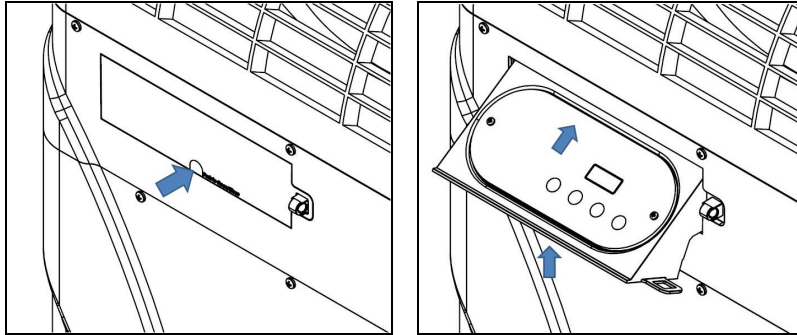

1.2 Energizing Heat Pump

Activate power at external fuse box or the breaker box.

- The heat pump performs a lamp test.
- The display reads **BBB**.
- The heat pump then displays as normal. See "Display" on page 4.

1.3 Wake Up Heat Pump

The heat pump's control panel has a sleep mode. This is used to prevent rain that hits the display from making unwanted setting changes.

To wake up the control panel, tap a button on the display until it illuminates. Then slowly slide a finger across the buttons.

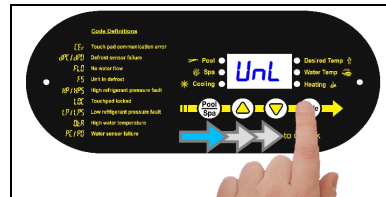

- The code **UnL** will briefly appear. Then either **FLO** or the water temperature will display.

1.4 Display Panel

The following information outlines the operation for a standard installation.

- Control Buttons will operate differently for custom installations; such as a heat pump connected to an external controller. See "Operating Heat Pump (With an External Controller)" on page 10.

Display Panel

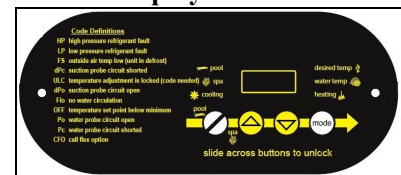

1.4.a Buttons

Buttons	Description
Display Lock	Sliding your finger across the buttons from left to right will temporarily disable the display lock.
Pool / Spa	Select either the pool or the spa thermostat.
Up Arrow	Used to increase temperature set point and navigate through menu options.
Down Arrow	Used to decrease temperature set point and navigate through menu options.
Mode	Select heat pump's operating mode.

1.4.b Display

Display	Description
75	The heat pump is on and displaying the current water temperature. In this example 75° F is displayed.
FLO	No water flow is detected. The filter pump is off or heat pump is not receiving correct water flow.
OFF	The heat pump has been turned off via the mode selector button or the temperature set point has been lowered below 45° F.
BBB	The control program is initializing. This displays only as power is applied to the heat pump.
CF I	Select water temperature format (in either Celsius or Fahrenheit).
ULC	Enable heat pump lockout feature.
ELC	Select pass code to lock the keyboard.
LDC	This is a Service Entry Point (not intended for use by the owner). The LDC code permits service personnel to enter a factory pass code to access adjustable calibration and site dependent setup parameters. Service adjustments are available to authorized installation and service personnel, only.

1.4.c Indicator Lights

Indicators	Description
Pool	The Heat Pump is referencing the pool thermostat.
Spa	The Heat Pump is referencing the spa thermostat.
Heating	Indicates the unit is heating the water. Please note - the compressor must be operating before this light will illuminate.
Cooling	Indicates the unit is cooling the water. Please note - the compressor must be operating before this light will illuminate.
Water Temp	Indicates current water temperature.
Desired Temp	Indicates temperature set point is displayed. This is displayed when "UP" or "DOWN" is selected.

1.5 User Level Programming

1.5.a User Level Factory Defaults

Certain programming options have been preset at the factory. These options can be overwritten for site-specific conditions.

NOTICE

Failure to heed the following may result in damage to equipment.

- Unauthorized adjustments in the Installer Menu (beyond the **LOC** menu) may void the heat pump's warranty.
- For further assistance, please see "*Contacting AquaCal AutoPilot, Inc.*" on page 1.

Table 1 - Factory Defaults

Code	Description	Default Value	Range
<i>OFF</i>	Heat Pump is deactivated.	<i>OFF</i>	
<i>HEA</i>	Heat water to point set on thermostat.		
<i>COO</i>	Cool water to point set on thermostat.		
<i>ACH</i>	Set to maintain a water temperature set on the thermostat.		
<i>CF 1</i>	Celsius / Fahrenheit Selection	1	0 = Celsius 1 = Fahrenheit
<i>ELC</i>	Enter Lock Code	0	0 - 99
<i>ULC</i>	User Lock Code	0	0 = "User Lock Disabled" 1 = "User Lock Enabled"

1.5.b Selecting Celsius or Fahrenheit



Press and Hold "UP" and "DOWN" until **CF 1** displays.

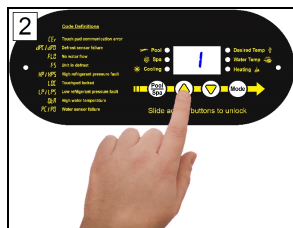

Press "UP" or "DOWN" button to select.

"0" - Celsius
"1" - Fahrenheit

1.5.c Setting Operating Mode

1. Press "Mode / Enter" button until desired mode is displayed.
2. After a certain amount of time, the display will show the selected mode and current water temperature.
 - Heating Mode - After fan and compressor starts, the red "Heating" light will activate.
 - Cooling Mode - After fan and compressor starts, the blue "Cooling" light will activate.
 - Holding Mode - After fan and compressor starts, the heat pump will attempt to maintain the set temperature within 3°. The red "Heating" or blue "Cooling" light will activate.
 - Off - The heat pump will indicate it is deactivated. The current water temperature will be displayed.

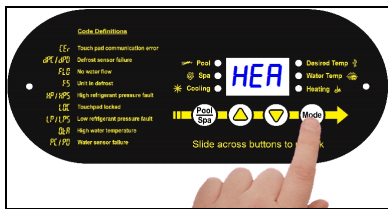

Heating Mode



Cooling Mode



Holding Mode



Deactivate Heat Pump

Heating / Cooling modes only available on select equipment. Confirm heat pump features before setting a mode.

1.5.d Setting Thermostats

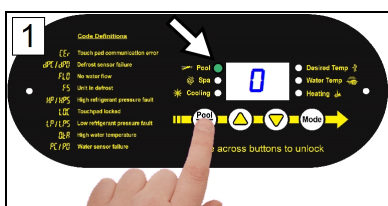

Select "POOL" or "SPA"



Press "UP" or "DOWN" to the desired temperature.

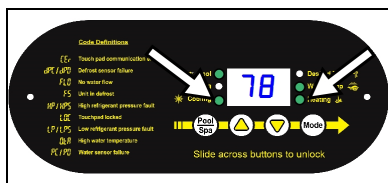

- The heating indicator will illuminate when heating the water.
- The cooling indicator will illuminate when cooling the water.

1.5.e User Lock Option (Enable)

The user-lock feature allows the heat pump display panel to be "locked". This can prevent unauthorized temperature adjustments in commercial applications.

- Do not confuse a user-lock with the display lock. See "Wake Up Heat Pump" on page 3.
- If **LOC** is briefly displayed, followed by a "0", the heat pump is already locked.
- If the user-lock code has been misplaced, please contact AquaCal® for further assistance.

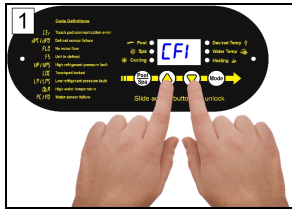

Hold "UP" and "DOWN" until **CFI** displays.



Press "POOL / SPA" button until **ELC** is displayed.



Press "UP or "DOWN" button to change or add a numerical password



Press "POOL / SPA" button to save the password.



Press "POOL / SPA" button until **ULC** is displayed.

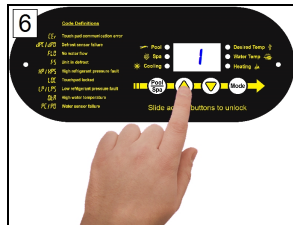

Press "Up" button till "1" is displayed to enable.

1.5.f User Lock Option (Disable)

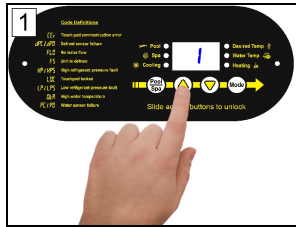

Use "UP" button to enter existing password.

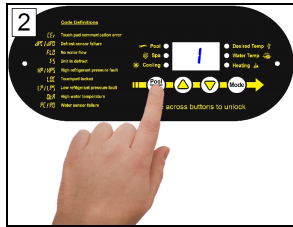

Press "Pool / Spa" button to unlock.



Hold "UP" and "DOWN" buttons until **CF 1** is displayed.



Press "POOL / SPA" button until **ULC** is displayed

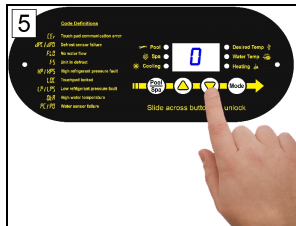

Press "DOWN" button until "0" is displayed.

1.5.g Using Pass Code to Access Heat Pump

If **LOC** is briefly displayed when attempting to change a heat pump's settings followed by a "0", the heat pump is in a user-lock mode. A numerical pass code is required to proceed.



Press "UP" or "DOWN" arrow to enter pass code.

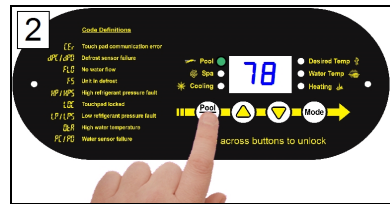

Press "POOL / SPA" button to unlock.

NOTE -

- After ten seconds of inactivity, the heat pump's display lock will activate. See "Wake Up Heat Pump" on page 3.
- If the user-lock code has been misplaced, please contact AquaCal® for further assistance.

1.5.h Operating Heat Pump (With an External Controller)

Controller with an internal thermostat control

Activating Heat Pump

1. Set the desired temperature at the external controller.
2. Use the external controller to select either the "Pool" or "Spa" to heat.

Deactivating Heat Pump

- Set the external controller to "OFF".

Please note - If equipped, the heat pump's cooling function **will be disabled** when using this type of controller.

If the cooling function is needed, the heat pump must be temporarily reprogrammed for local control. Check with controller installer if heat pump needs to be re-programmed.

Controller with 2 positions - ("Pool" and "Spa" - *no internal thermostat control*)

Activating Heat Pump

1. Set the desired temperatures on the heat pump thermostats. See "Setting Thermostats" on page 7.
2. Use the external controller to select either the "Pool" or the "Spa" thermostat.
 - *Rapid movement between thermostats without a "rest" between each change can cause a missed signal by the heat pump.*

Deactivating Heat Pump

- Go to the heat pump and set the mode to "OFF". See "Setting Operating Mode" on page 7.

Please note - If equipped, the heat pump's cooling function **will be disabled** when using this type of controller.

If the cooling function is needed, the heat pump must be temporarily reprogrammed for local control. Check with controller installer if heat pump needs to be re-programmed.

Controller with 3 positions - ("High", "Low", and "Off" - *no internal thermostat control*):

Activating Heat Pump

1. Set the desired temperatures on the heat pump thermostats. See "Setting Thermostats" on page 7.
2. Use the external controller and select the "High" or "Low" thermostat.
 - *When changing between thermostats, select "Off" first. Then select desired thermostat.*
 - *Rapid movement between thermostats without a "rest" between each change can cause a missed signal by the heat pump.*

Deactivating Heat Pump

- Set the external controller to "OFF".

2 - Maintenance

2.1 Water Chemistry

Check water chemistry regularly and maintain within recommended levels. Standards vary in different residential and commercial applications. Follow all local applicable codes.

NOTICE

Failure to heed the following may result in damage to equipment.

- Do not allow water to flow through heat pump when refinishing or acid washing a pool. Either use an installed bypass to route water away from heat pump or deactivate filter pump.
- To avoid damage to equipment, monitor and maintain chemistry within recommended levels.

CHEMISTRY LEVEL CHART (RESIDENTIAL)		
CHEMICAL	POOLS	SPAS
Chlorine	1.0 – 3.0 ppm	3.0 – 5.0 ppm
Bromine	2.0 – 6.0 ppm	2.0 – 6.0 ppm
Cyanuric Acid	30 – 50 ppm	30 – 50 ppm
pH	7.4 – 7.6 ppm	7.4 – 7.6 ppm
Total Alkalinity	80 – 120 ppm	80 – 120 ppm
Calcium Hardness	200 – 400 ppm	150 – 250 ppm
Total Dissolved Solids*	0 – 1,500 ppm	1,500 ppm above start-up of total dissolved solids in spas

* Salt from a chlorine generator is not included in Total Dissolved Solids.

2.2 Cleaning Equipment

Cleaning and polishing your heat pump regularly can protect its appearance and longevity. More frequent servicing may be required for heat pumps located in sandy or coastal areas where sand and salt spray can damage equipment.

WARNING

Failure to heed the following may result in injury or death.

- Possible electric shock hazard - Deactivate power to all electrical devices on the pad when washing heat pump. Do not restore electrical power until equipment is completely dry.

NOTICE

Failure to heed the following may result in damage to equipment.

- Do not use a pressure cleaner to wash heat pump. Damage to heat pump components may result. If using a hose-end spray nozzle adjust spray pattern to low strength only.
- Do not spray water directly into the interior of the heat pump; damage to components may result.
- Do not use chemicals on the display panel.

Cleaning

1. Wash outside cabinet using a low-pressure water hose. A high-pressure water stream will cause damage to the aluminum fins of the heat pump. This damage is not covered under product warranty.
2. While the heat pump is still wet, use an approved cleaning agent to clean the exterior of the heat pump. **Do not use chemicals on the display panel.**
3. Use a detergent-dampened cloth to wipe the heat pump's exterior cabinet.
4. Flush all exterior with fresh water using a low-pressure water hose.
5. Dry the exterior cabinet using a soft cloth being careful not to damage evaporator fins.

APPROVED CLEANING AGENTS*
Fantastic [®]
Formula 409 [®]
Cascade [®]
All Power Plain Detergent (3% Solution)

Table 2 - Cleaning Agents

Polishing

1. Polish the heat pump's cabinet panels using an approved polishing agent and following the manufacturer's instructions. Do not use chemicals on the display panel.
2. Rinse the heat pump panels with fresh water, wipe, and buff panels using a dry soft cloth.
3. Allow heat pump interior and surrounding equipment to "air-dry" for several hours prior to restoring electrical power.

APPROVED POLISHING AGENTS*
Simoniz [®] Wax
Glo-Coat [®]
Armor All [®] Protectant

Table 3 - Polishing Agents

- * The trademarks used in approved cleaning and polishing agents are property of their owners and are not related to AquaCal[®].

2.3 Clearances

- Proper air circulation is required for the heat pump to operate efficiently. The following diagrams show the minimum clearances required for the proper operation of the heat pump.
- Avoid storing chemical containers near the heat pump. The chemicals can cause equipment damage.
- Avoid placing objects near or on top of the heat pump. This includes shrubbery and lawn furniture. These objects will reduce performance and efficiency and hinder maintenance access.

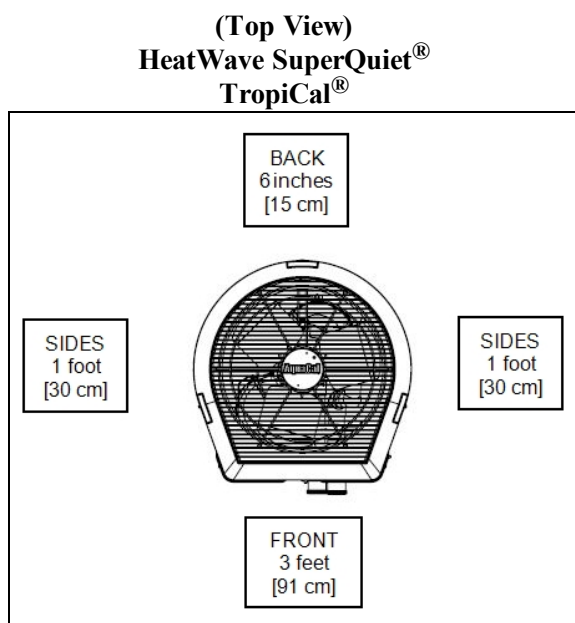
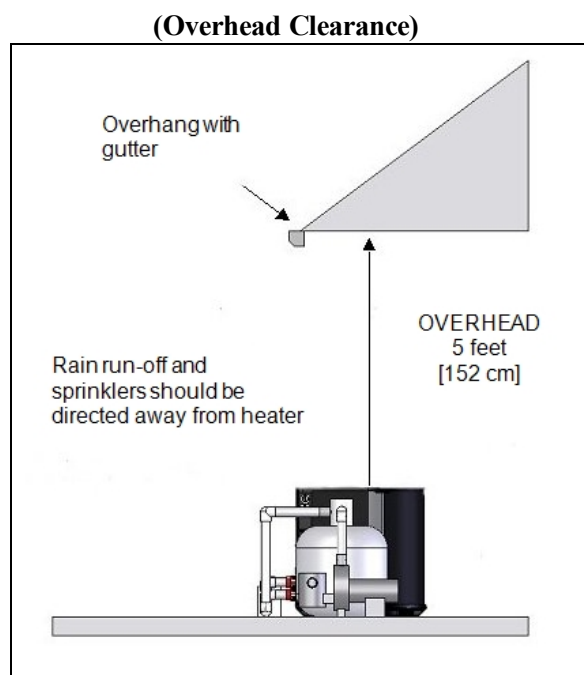

2.4 Irrigation and Storm Run-Off

- Irrigation water may damage heat pump components. Direct irrigation water away from the heat pump.
- The heat pump will withstand normal rainfall. Do not allow a roof slope to direct rainwater onto the heat pump. Have a gutter installed on the roof edge to direct this water away from the heat pump. Or install the heat pump in another location.

2.5 Water Flow Rates

Maintain water flow rates as indicated. Please note, these specifications relate to the heat pump only. Code-specified whole system turnover rates must be satisfied.

NOTICE

Failure to heed the following may result in damage to equipment.

- Water flow exceeding maximum flow rates will negatively affect the total pool filtration performance and may damage the heat pump. This will not be covered under equipment warranty.

MODEL	HEAT EXCHANGER TYPE	FLOW RATES	
		MINIMUM	MAXIMUM
SQ120R	Titanium ThermoLink®	30 GPM	70 GPM
SQ125	Titanium ThermoLink®	30 GPM	70 GPM
SQ145	Titanium ThermoLink®	30 GPM	70 GPM
SQ166R	Titanium ThermoLink®	30 GPM	70 GPM
SQ225	Titanium ThermoLink®	30 GPM	70 GPM
T035	Titanium Tube-in-Tube	20 GPM	45 GPM
T055	Titanium Tube-in-Tube	20 GPM	45 GPM
T075	Titanium Tube-in-Tube	20 GPM	45 GPM
T090	Titanium ThermoLink®	30 GPM	70 GPM
T115	Titanium ThermoLink®	30 GPM	70 GPM
T135	Titanium ThermoLink®	30 GPM	70 GPM

PLEASE NOTE -

If minimum flow rates are not met, heat pump performance is reduced and performance will suffer. Internal safety devices may deactivate the heat pump with the following errors:

- **HP** and **HP5**
 - or (if equipped) error codes of **LP** and **LP5**
- Operate water filtration devices per manufacturer's specifications. Dirty filters can cause a reduction of water flow to the heat pump. An increase of 7-10 psi higher than the clean filter pressure typically reduces flow rates. This requires the filter to be cleaned or back-washed.
 - Keep baskets free of debris. A large quantity of debris in the pump and skimmer baskets can reduce water flow.

- Check for improper valve settings. A partially closed valve after the filter, or a full-open bypass around the heat pump, will cause insufficient water flow through the heat pump.
- The maximum static pressure (or operating pressure) is 50 pounds-per-square-inch (PSI). These specifications relate to the heat pump only.
- Code-specified whole system turnover rates must be satisfied.

2.6 Adjusting Water Flow Using ΔT (Delta-T)

The Delta-T is the temperature difference between the water temperatures entering and leaving the heat pump. The equipment can be fine-tuned for maximum performance by balancing water flow rates to maintain an ideal ΔT .

- Installed temperature ports are required to perform the following procedures.
- **This adjustment procedure must be completed with the unit in heating mode.**

PLEASE NOTE -

- The installation of temperature ports are required for all commercial applications.
- The installation of temperature ports are strongly recommended for residential installations.
- See "Temperature Port Kit" on page 22.

1. Adjust thermostat to its lowest setting with unit in heating mode.
2. Deactivate the water filtration pump.
3. Confirm that the filters leading to the heat pump are clean.
4. Adjust the valves controlling water headed towards the heat pump to the half open position.
5. Adjust the valves controlling water leading away from the heat pump to a fully open position.
6. Activate the pool water filtration pump.
7. Slowly raise the thermostat temperature until the heat pump activates.
 - After a four-minute delay, the heat pump's compressor will start.
8. With the heat pump running, confirm water filtration pump is operating properly with adequate flow and no short cycling.
9. Wait for water temperatures to stabilize (approximately 5 minutes).
10. Adjust valves in the following order:
 - a. Adjust the valve that controls water exiting the heat pump. Match the temperature measured with a temperature probe to the chart. (See "Temperature Chart" in this section)
 - b. Wait for water temperatures to stabilize. Then check temperature again. Re-adjust the valve controlling the water exiting the heat pump as needed.
11. Mark valves at these positions for future reference.

**Temperature Port
(Shown with Probe)**



MODEL	TEMPERATURE
SQ120R	3° to 7° F
SQ125	3° to 7° F
SQ145	3° to 7° F
SQ166R	3° to 8° F
SQ225	4° to 9° F
T035	1° to 4° F
T055	2° to 5° F
T075	3° to 7° F
T090	3° to 6° F
T115	3° to 7° F
T135	4° to 8° F

Table 4 - Temperature Chart

PLEASE NOTE -

- Temperature differences are based on pool water temperatures of 69° to 75° F.
- For water temperatures outside this range, contact AquaCal®. See "Contacting AquaCal AutoPilot, Inc." on page 1.

2.7 Planned Maintenance

An annual inspection and maintenance program is strongly recommended starting no later than one year after installation of the heat pump. In harsh environments or coastal areas a bi-annual inspection is recommended. See recommended inspection checklist.

AquaCal® can perform this service in limited areas. Contact Customer Support for more information.



Failure to heed the following may result in injury or death.

- Annual inspection and service must be performed by a qualified heat pump specialist in order to prevent physical injury or damage to equipment. For tasks requiring handling refrigerant, an HVAC license is required.

Recommended Inspection Checklist:
1. Clean Evaporator Coil
2. Check Contactor Points
3. Check Fan Capacitor Values
4. Check Fan Blade Clearances
5. Clean Heat Pump Cabinet
6. Check Flow / Pressure Switch

Recommended Inspection Checklist:
7. Apply Rust Inhibitors (As applicable)
8. Verify / Check Air Flow Delta
9. Verify / Check Water Flow Delta
10. Check Fan Motor Amperage Draw
11. Check and Clear Condensate Drains
12. Check Compressor Capacitor Values
13. Check Compressor Amperage Draw
14. Check Internal Electrical Connections
15. Check Operating Refrigerant Pressures (As Applicable)
16. Check Ambient and Water Temperature Sensors
17. Check Proper Line and Control Voltage to Unit
18. Identify Insect and Rodent Issues with Unit
19. Identify Environmental Conditions of Concern (Run-Off, Sprinklers, etc.)
20. Perform Operating Orientation (As Applicable)

2.8 Winterizing

Failure to properly winterize the heat pump as needed may result in serious equipment damage.

WARNING

Failure to heed the following may result in injury or death.

- Deactivate all electrical power to heat pump before performing hard freeze procedures.

NOTICE

Failure to heed the following may result in damage to equipment.

- Failure to winterize heat pump may result in serious equipment damage. Freeze damage is not covered under the heat pump warranty.
- While the plumbing connections are in the winterized condition (not fully tightened), it is imperative that water not run through the heat pump. Loss of water through loose plumbing connections may result in damage to circulation pump, pool and spa structures, and other equipment.

Light Freeze Conditions

A light freeze is when the ambient air temperature falls below 32 degrees Fahrenheit for less than 8 hours. Typically during light freeze conditions circulating (or moving) water will not freeze. Temporarily activate the filter pump for continuous operation during light freeze conditions.

Hard Freeze Conditions

A hard freeze is when the ambient air temperature falls below 32 degrees Fahrenheit for more than 8 hours. In areas where this condition is prevalent and sustained, the heat pump **MUST** be winterized for hard freeze conditions. Follow the correct procedure depending on the type of heat exchanger found in the heat pump.

Identify Exchanger:

1. Deactivate all electrical power to heat pump.
2. Deactivate filter pump.
3. Remove front access panel. See "Access Panels"
4. Identify heat exchanger from illustrations in this section. Then follow procedure for the appropriate heat exchanger.

Titanium ThermoLink® Exchanger (with no Drain)

5. Reinstall front access panel.
6. Disconnect the plumbing to the heat pump at connection unions (removal is counter-clockwise).
7. Allow water to drain completely from the heat pump. Expect to see a lot of water drain out at first, and then a small amount to continue to drain out over a long period.
8. After heat pump has fully drained, partially reconnect plumbing connection unions.
9. Winterizing is complete.
10. When ready to use heat pump again, hand-tighten connection unions. Reconnect electrical power, and set the operating mode on the heat pump. Activate filter pump.

No Drain



Titanium Tube-in-Tube Exchanger

5. Reinstall front access panel.
6. Disconnect the plumbing to the heat pump at connection unions (removal is counter-clockwise).
7. Allow water to drain completely from the heat pump. Expect to see a lot of water drain out at first, and then a small amount to continue to drain out over a long period.
8. Place an air hose into the pool inlet of the heat pump; wrap a clean rag around the hose to form a temporary seal.
9. Push all water from the water circuit using compressed air no stronger than 50 psig. The residual water should be forced out of the heat pump's water outlet. Allow compressed air to blow into the heat pump inlet for at least 15-20 seconds after the water stops coming out.
10. Repeat process on the outlet side of the heat pump.
11. Partially reconnect plumbing connection unions.
12. Winterizing is complete.
13. When ready to use heat pump again, hand-tighten connection unions. Reconnect electrical power, and set the operating mode on the heat pump. Activate filter pump.

**Titanium
Tube-in-
Tube**

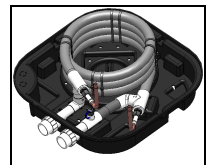

3 - Appendix

3.1 Identifying Model Specifications

1. Find Data Plate - The data plate is usually posted on the side of the equipment or the inside of the heat pump's access plate.
2. Find the model number on the data plate. The first letters and numbers indicate the model type.
3. The complete model number identifies the equipment's specifications.

Data Plate Example

MINIMUM CIRCUIT AMPACITY	<input type="text"/>	MADE IN THE USA
ELEC. SERVICE: VOLTS	<input type="text"/>	PH <input type="text"/> HZ <input type="text"/>
MAXIMUM TIME DELAY FUSE OR HACR BREAKER	<input type="text"/>	5
COMPRESSOR VOLTS	<input type="text"/>	R.L.A. <input type="text"/> L.R.A. <input type="text"/>
FAN MOTOR VOLTS	<input type="text"/>	H.P. <input type="text"/> F.L.A. <input type="text"/>
REFRIGERANT: Circuit - Factory charged	<input type="text"/>	Only oz/Kg <input type="text"/>
Tested to	<input type="text"/> psig High side /	<input type="text"/> psig Low side
OUTDOOR USE		
AQUA CAL, INC. A TEAM HORNER COMPANY 2737 24 TH STREET NORTH ST. PETERSBURG, FL 33713 FACTORY SERVICE 727-523-5642	MODEL NUMBER <input type="text"/>	IIIBAR CODEIII
	SERIAL NUMBER <input type="text"/>	IIIBAR CODEIII

Model Number Example

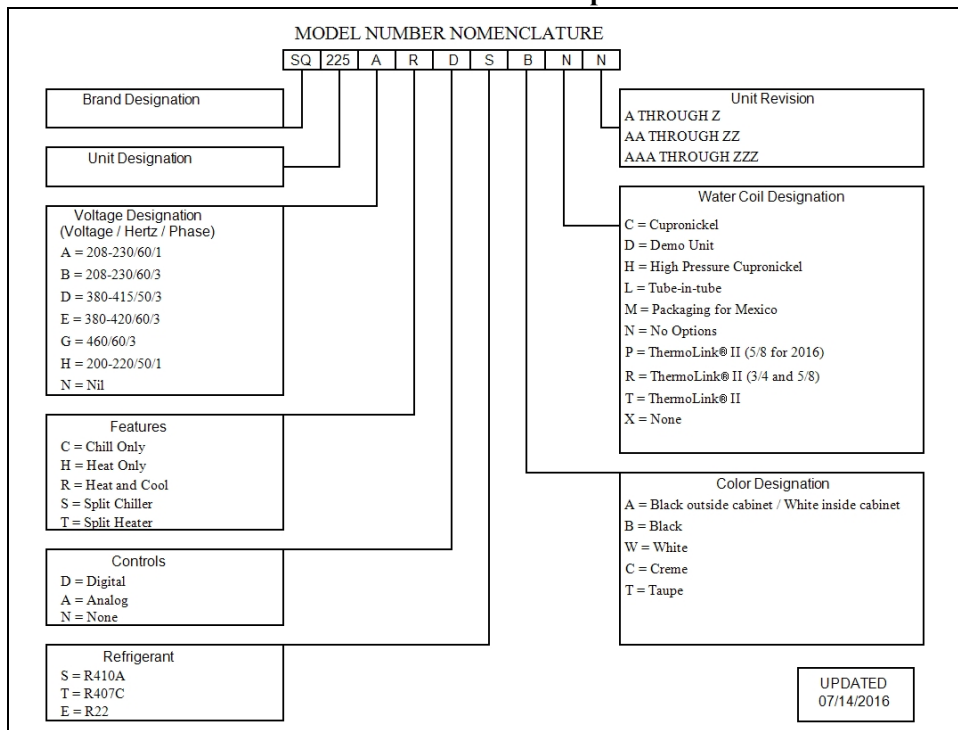

3.2 Weights

NOTE:

Specifications subject to change.

Model Type	Model Number	Install Weight
TropiCal®	T035	180 Pounds
TropiCal®	T055	180 Pounds
TropiCal®	T075	200 Pounds
TropiCal®	T090	255 Pounds
TropiCal®	T115	259 Pounds
TropiCal®	T135	287 Pounds
HeatWave SuperQuiet®	SQ120R	268 Pounds
HeatWave SuperQuiet®	SQ125	268 Pounds
HeatWave SuperQuiet®	SQ145	328 Pounds
HeatWave SuperQuiet®	SQ166R	328 Pounds
HeatWave SuperQuiet®	SQ225	328 Pounds

Table 5 - Equipment Weight

3.3 Heating Recommendations

The following recommendations will reduce the amount of time required to heat a pool. **If unsure of equipment heating capability, review equipment data plate.** See "Identifying Model Specifications" on page 19.

1. Confirm heat pump mode has been set to heating mode.
2. Set thermostat to desired water temperature.
3. Temporarily set the filter pump for continuous operation.
 - This will allow the Heat Pump the time required to heat the water at start-up.
 - After the water has reached the desired temperature, reset the filter pump to normal operating time-frames.
4. Use a pool cover or blanket to reduce heating time.

3.4 Cooling Recommendations

The following recommendations will reduce the amount of time required to cool a pool or cold plunge application. **If unsure of equipment cooling capability, review equipment data plate.** See "Identifying Model Specifications" on page 19.

1. Confirm heat pump mode has been set to cooling mode.
2. Set thermostat to desired water temperature.
3. Temporarily set the filter pump for continuous operation.
 - This will allow the Heat Pump the time required to cool the water at start-up.
 - After the water has reached the desired temperature, reset the filter pump to normal operating time-frames.

3.5 Available Accessories

Accessories may be purchased through an authorized dealer of AquaCal products.

For further assistance, please see "Contacting AquaCal AutoPilot, Inc." on page 1.

5 lb Bypass Valve Kit (# STK0135)

- When high flow rates are outside recommended specifications, please use this kit or an alternative bypass valve system.
- This kit can be used to control excessive water flow through the heat pump. It provides automatic flow adjustments for most applications.

Condensation Drain Kit (# STK0202)

- Used when condensation water flow must be directed to a specific location.

Automatic Sequencing Controller

- An Automatic Sequencing Controller (ASC) provides easy control of all units from one lead unit and prevents the simultaneous start-up of multiple heat pumps.
- Site voltage drop is minimized and utilities are not subjected to large in-rush demands of electrical current.
- Part number is based on number of heat pumps to be controlled. Call AquaCal® for assistance with correct configuration. See "Contacting AquaCal AutoPilot, Inc." on page 1.

External Flow Relay (Grid Flow Switch) Kit (0040S)

- Used when the pool / spa elevation is higher than the heat pump.
- Also used for automatic pool / spa thermostat switching.

PLEASE NOTE -

The kit is not to be used on applications exceeding 50 PSI.

Liquid Blankets

- An invisible liquid heat barrier designed to retain heat and extend the swimming season.
- AquaCal® recommends [Lo-Chlor](#)® Aqua Blanket™.



Plumbing Unions:

SIZE	PART NUMBER
2 INCH	PLS2627

Remote Control Kit (STK0070)

- A remote (wired) control kit allows for full control of the heat pump from up to 100 feet from the equipment.

Temperature Port Kit

- This kit is used to install a temperature port.
- This port can be used to adjust water flow using Delta-T. The kit comes with port, installation components, and a temperature probe.

PART NUMBER

Kit # (STK0096)

4 - Troubleshooting

4.1 Fault Codes

A fault code indicates a specific issue or condition that will require action before the equipment can resume operating.

Please perform the following troubleshooting.

If the issue reoccurs, please see "*Contacting AquaCal AutoPilot, Inc.*" on page 1.

WARNING

Failure to heed the following may result in injury or death.

- Repairs must not be attempted by untrained or unqualified individuals.
- The heat pump contains refrigerant under high pressure. Repairs to the refrigerant circuit must not be attempted by untrained or unqualified individuals. Service must be performed only by qualified HVAC technicians. Recover refrigerant before opening the system.

NOTICE

Failure to heed the following may result in damage to equipment.

- Service by unauthorized personnel will void the heat pump warranty.

FLO Indicator

ISSUE

Low or no water detected.

RESOLUTION

1. Confirm the filter pump is on.
2. If a multiple-speed filter pump is being used, run at a higher speed to determine if the error persists. Do not exceed maximum flow rate for your model.
3. Confirm water is not being diverted away from the heat pump.
 - See "Water Flow Rates" on page 14.
 - See "Adjusting Water Flow Using ΔT (Delta-T)" on page 15.

F5 Indicator

ISSUE

The heat pump has sensed the evaporator coil is icing up.

RESOLUTION

When ice starts to form on the coil, the heat pump will stop heating or cooling the water for 10 minutes. Hot refrigerant gas will be sent through the coil to rapidly remove ice or frost. During this process, the melting of the ice may appear as steam coming off the heat pump. This is normal.

- After the 10 minute defrost cycle has expired, the heat pump will resume heating or cooling the water.
- If after 50 minutes, the heat pump senses the coil still has ice on it, the defrost cycle will resume.

CEr Indicator

ISSUE

This can indicate a loose or damaged communication cable.

RESOLUTION

A qualified technician should check the cable from control board to display assembly for a loose connection or visible damage.

CSE Indicator

ISSUE

This is a control system error.

RESOLUTION

Deactivate then reactivate power to reset controls.

dPC or dPD Indicator

ISSUE

Shorted or open defrost sensor.

RESOLUTION

A qualified technician should replace the defrost sensor.

PC or PD Indicator

ISSUE

Shorted or open water sensor.

RESOLUTION

A qualified technician should replace the water sensor.

HP Indicator

ISSUE

The refrigerant system's high-pressure switch is showing as open.

RESOLUTION

If the heat pump is a reversing unit, place it in **HEA** mode and perform the following troubleshooting.

Determine if an insufficient amount of water is being supplied to the equipment.

1. Confirm the filter pump is on.
2. If a multiple-speed filter pump is being used, run filter pump at a higher speed. Do not exceed maximum flow rate for the model.
3. Confirm water is not being diverted away from the heat pump.
 - See "Water Flow Rates" on page 14.
 - See "Adjusting Water Flow Using ΔT (Delta-T)" on page 15.
4. The water pressure switch may be incorrectly calibrated. See "Adjusting Water Pressure Switch" for more information.

HP5 Indicator

ISSUE

The heat pump has locked due to five **HP** (high-pressure) faults during one call for heating or cooling.

RESOLUTION

1. Deactivate then reactivate power to the heat pump to clear error.
2. Troubleshoot the high-pressure issue causing the error. See "HP Indicator" on page 24.

LP Indicator

ISSUE

The refrigerant system's low-pressure switch is showing as open.

RESOLUTION

If the heat pump is a reversing unit, place it in **HEA** mode and perform the following troubleshooting.

1. Check for proper fan operation. If fan is not operating, contact AquaCal®.
2. Check for obstructed air flow around the heat pump. See "Clearances" on page 13.
3. Check for dirty or blocked evaporator coil. See "Cleaning Equipment" on page 12.
4. Check for signs of heavy ice buildup on the coil.

LP5 Indicator

ISSUE

The heat pump has locked due to five **LP** (low-pressure) faults during one call for heating or cooling.

RESOLUTION

1. Deactivate then reactivate power to the heat pump to clear error.
2. Troubleshoot the low-pressure issue causing the error. See "LP Indicator" on page 25.

OWT Indicator

ISSUE

Incoming water temperature exceeded 110° F and the unit is locked with an **OWT** over temperature alarm. The heat pump will not operate until incoming water temperature drops to 100° F or lower.

RESOLUTION

1. Determine if another heat source (gas heater, solar heater, etc.) is heating water being sent directly to the heat pump with the **OWT** indicator. This situation will need to be corrected before continuing.
2. Rule out an incorrect reading from the water temperature sensor. Verify existing water temperature with an accurate thermometer. If heat pump's sensor is inaccurate, the water temperature sensor may require replacement.

4.2 Issues and Resolutions

WARNING

Failure to heed the following may result in injury or death.

- Repairs must not be attempted by untrained or unqualified individuals.
- The heat pump contains refrigerant under pressure. Repairs to the refrigerant circuit must not be attempted by untrained or unqualified individuals. Service must be performed only by qualified HVAC technicians. Recover refrigerant before opening the system.

NOTICE

Failure to heed the following may result in damage to equipment.

- Service by unauthorized personnel will void the factory warranty.

Please perform the following troubleshooting.

For further assistance, please see *"Contacting AquaCal AutoPilot, Inc."* on page 1.

Display Panel Not Responding

1. If the heat pump is controlled by an external controller, confirm the external controller settings. See "Operating Heat Pump (With an External Controller)" on page 10.
2. If the issue is still occurring, contact the installer or manufacturer of the external control device.

Heat Pump Not Running

1. Confirm equipment is receiving power. Is the heat pump display illuminated?
 - If not, confirm the main breaker (located at the power supply panel) and the disconnect switch (located near the heat pump) are both turned on.
 - If the display still does not illuminate, it is recommended that the heat pump installer or electrician confirm heat pump is receiving power.
2. Confirm correct mode is selected. See "Setting Operating Mode" on page 7.
3. Confirm thermostat is set correctly. See "Setting Thermostats" on page 7.
 - When heating the water is desired, the thermostat should be set above the current water temperature.
 - When cooling the water is desired, the thermostat should be set below the current water temperature.
4. If an error code is displayed, diagnose and correct the cause of the code. See "Fault Codes" on page 23.
5. If the heat pump is using an external controller, the heat pump may not be set correctly to accept the controller's signal.
 - See "Operating Heat Pump (With an External Controller)" on page 10.

Heat Pump's Tripping Breaker

1. Have an electrician confirm breakers are in good condition and properly sized for the heat pump.
2. Multiple heat pumps installed at the same site may benefit from special automatic sequencing controllers to avoid excessive power drops at start-up. See "Automatic Sequencing Controller" on page 21.
3. If a fault occurs immediately when the compressor starts, a qualified technician should evaluate the system.

Heat Pump Won't Shut Off

PLEASE NOTE

When heat pump is set to "OFF", the display will show either the water temperature or FLD.

1. Confirm the heat pump has reached the desired temperature set on the thermostat. The heat pump will continue to run until the set temperature is reached.
2. If the heat pump is using an external controller, it may not be set correctly.
 - See "Operating Heat Pump (With an External Controller)" on page 10.

Heat Pump Is Running, Not Heating

1. If the heat pump is using an external controller, confirm it is set correctly.
 - See "Operating Heat Pump (With an External Controller)" on page 10.
 - If the heat pump is still not running correctly with this device, contact the installer of the external controller device or the device's manufacturer for further assistance.
2. Confirm heat pump mode is set to **HEA** operating mode.
3. Confirm thermostat is set to the desired water temperature.
4. Confirm valves are correctly positioned to heat the correct body of water (either the pool or the spa). If heating a spa that overflows into a pool, confirm the spa is isolated when being heated (not flowing into the pool).
5. Confirm heat pump is transferring heat into the water.
 - Measure the temperature of air discharge coming out of the heat pump fan. If discharge air is between 8° to 10° colder than the outside ambient air, the heat pump is moving heat into the water.
6. If an error code is displayed, diagnose and correct cause of code. See "Fault Codes" on page 23.
7. Confirm that filter pump has a sufficient run-time. The heat pump will not run (or heat the water) without water flow. Heat Pump equipment will generally be set to run 24 hours a day in commercial applications. See "Heating Recommendations" on page 20.
8. If heating a spa, deactivate air blower or venturi (if equipped) to allow for quicker heating times. For pools, deactivate water features, such as slides, waterfalls, or fountains to allow water to retain heat. Use of a liquid pool blanket product can also compensate for excessive heat loss.
 - See Available Accessories on page 21 for more information on liquid blankets.

Heat Pump Is Running, Not Cooling (Reversing Models)

1. If the heat pump is using an external controller, confirm the heat pump is programmed properly to allow for cooling. See "Operating Heat Pump (With an External Controller)" on page 10.
2. Confirm the heat pump mode is set to **COO** operating mode.
3. Confirm the thermostat is set below the current water temperature.
4. Confirm valves are correctly positioned to cool the correct body of water (either the pool or the spa). If cooling a spa that overflows into a pool, confirm the spa is isolated when being cooled (not flowing into the pool).
5. If an error code is displayed, determine and correct the condition causing the code. See "Fault Codes" on page 23.
6. Confirm heat pump is transferring heat out of the water.
 - Measure the temperature of air discharge coming out of heat pump's fan. If the air is between 8° to 10° warmer than the outside ambient air, the heat pump is moving heat out of the water.
7. Confirm that filter pump has a sufficient run-time. The heat pump will not run (or cool the water) without water flow. Heat Pump equipment will generally be set to run 24 hours a day in commercial applications. See "Cooling Recommendations" on page 20.

Water Coming From Heat Pump

The water may be normal condensation produced as a by-product of the heat pump's refrigeration process. The heat pump can produce 8 to 10 gallons of condensation per day depending on the humidity of the ambient air. Determine if the water is condensation or a possible leak.

1. Deactivate heat pump, leaving the filter pump on. After several hours, determine if water is still coming from the heat pump.
2. If using chlorine or bromine as a pool / spa sanitizer, test the water around the heat pump using a test strip. If the test strip indicates that chlorine or bromine is present, a leak may exist.

PLEASE NOTE -

If desired, a kit is available to re-direct condensation water away from the heat pump. See "Condensation Drain Kit (# STK0202)" on page 21.

Ice Forming on the Heat Pump

Why ice and frost appear:

1. When the heat pump operates, air is pulled into the unit and across the cold air coil.
2. As heat is removed from the air, moisture in the air will condense on the surface of the air coil (condensation).
3. Depending on the humidity level, when air temperatures are below 50°F this condensate can begin to freeze. Forming frost then ice.

What to expect:

- The heating of the pool or spa water continues while frost and ice develop.
- The heat pump is designed to periodically enter a “defrost” stage to remove the accumulated frost and ice.
- During the “defrost” stage, pool or spa heating is suspended till the end of the “defrost” cycle.

Troubleshooting:

1. The heat pump can be more efficient if used during warmer parts of the day. This heat gain can be retained during the colder parts of the day by using a pool blanket.
2. If the heat pump forms sheets of ice that never go away during a cold season, conditions may not allow for proper heat transfer. And the heat pump should be turned off.
3. If the ambient air temperature is warm and ice is appearing on the heat pump, turn off the heat pump. Service may be required.