

AquaCal[®]

Installation Manual

GBB

GREAT BIG BOPPER



Important

Read this document before operating / installing this product

For additional product manuals and operation / installation procedures, please visit www.AquaCal.com

MODEL / SERIAL NUMBER

Table of Contents

Section 1 - Contacting AquaCal AutoPilot, Inc.

Section 2 - Safety

Section 3 - Installation

3.1 Dimensions	2
3.2 Positioning Equipment	2
3.2.a Controlling Irrigation and Rainwater Runoff	2
3.2.b Planning for Condensation	2
3.2.c Mounting Pad Requirements	3
3.2.d Anchoring to Pad	3
3.3 Plumbing	3
3.3.a Clearances	3
3.3.b Water Flow Rates	3
3.3.c Adjusting Water Flow Using ΔT (Delta-T)	4
3.3.d Plumbing Requirements	5
3.3.e Plumbing Diagrams	5
3.3.f Water Connections to Heat Pump	9
3.3.g In-Line Chlorine Feeders	10
3.3.h Maintaining Ability to Winterize	10
3.3.i Adjusting Water Pressure Switch	10
3.4 Electrical	11
3.4.a Electrical Requirements	11
3.4.b Electrical Standards	12
3.4.c Grounding and Bonding	12
3.4.d Surge Suppression	12
3.4.e Sizing the Electrical Service	12
3.4.f Schematics	12
3.4.g Verifying Transformer Setting	12
3.4.h Three-Phase Adjustment	13
3.5 Connecting Heat Pump to an External Controller	14
3.6 Programming	17
3.6.a Factory Defaults	17
3.6.b Deactivate Time Delay	18
3.6.c Reset to Factory Defaults Settings	19

Section 4 - Operation

4.1 Energizing Heat Pump	19
4.2 Display Lock	19
4.3 Control Panel	19
4.4 Buttons	20
4.5 Indicator Lights	20
4.6 Display	20
4.7 Factory Defaults	21
4.8 Setting Operating Mode	22
4.9 Setting Thermostats	22
4.10 Selecting Celsius or Fahrenheit	22

4.11 User Lock Option (Enable)	22
4.12 User Lock Option (Entering Pass Code)	23
4.13 User Lock Option (Disable)	24
4.14 Operating Heat Pump (With an External Controller)	24
Section 5 - Maintenance	
5.1 Water Chemistry	25
5.2 Cleaning Equipment After Installation	26
5.3 Winterizing	27
Section 6 - Troubleshooting	
6.1 Fault Codes	28
6.2 Issues and Resolutions	31
Section 7 - Appendix	
7.1 Identifying Model Specifications	34
7.2 Weights	35
7.3 Access Panels	35
7.4 Initial Heating Recommendations	35
7.5 Initial Cooling Recommendations	35
7.6 Available Accessories	36
7.7 Schematics	36
Schematic LTM0214	37

SECTION 1 - CONTACTING AQUACAL AUTOPILOT, INC.

For further assistance, please contact AquaCal AutoPilot, Inc. Technical Support. To better assist you, please have the heat pump model and serial number available. See "Identifying Model Specifications" on page 34.



Website	www.AquaCal.com
Request Service Online	www.AquaCal.com/request-heat-pump-service/
Phone	(1) 727-823-5642
Hours	8-5 pm, Eastern M-F

SECTION 2 - SAFETY



- For personal safety, and to avoid damage to equipment, follow all safety instructions displayed on the equipment and within this manual. Repair and service of heat pump must be performed by an authorized service center.
- Warranties may be voided if the equipment has been improperly installed, maintained or serviced.
- If service is deemed necessary, please contact AquaCal® Technical Support. See "Contacting AquaCal AutoPilot, Inc." on page 1.

SAFETY SIGNALS

Throughout this document, safety signals have been placed where particular attention is required.

-  **WARNING** - signals relate to personal safety.
-  **CAUTION** - signals promote avoiding damage to the equipment.

When installing and using your heat pump basic safety precautions must always be followed, including the following:

-  **WARNING** - Failure to heed the following may result in injury or death.
 - Installation and repairs must be performed by a qualified technician.
 - The heat pump utilizes high voltage and rotating equipment. Use caution when servicing.
 - Electrical installation and service should be performed by a Licensed Electrician only.
 - Improper water chemistry can present a serious health hazard. To avoid possible hazards, maintain pool / spa water per standards detailed in this document.
 - Prolonged immersion in water warmer than normal body temperature may cause a condition known as Hyperthermia. The symptoms of Hyperthermia include unawareness of impending hazard, failure to perceive heat, failure to recognize the need to exit the spa, and unconsciousness. The use of alcohol, drugs, or medication can greatly increase the risk of fatal Hyperthermia. In addition, persons having an adverse medical history, or pregnant women, should consult a physician before using a hot tub or spa. Children and the extreme elderly should be supervised by a responsible adult.
 - Prolonged immersion in water colder than normal body temperature may cause a condition known as Hypothermia. The symptoms of Hypothermia include shivering (although as hypothermia worsens, shivering stops), clumsiness or lack of coordination, slurred speech or mumbling, confusion and poor decision-making, drowsiness or low energy, lack of concern about personal welfare, progressive loss of consciousness, weak pulse and slow or shallow breathing. In addition, persons having an adverse medical history, or pregnant women, should consult a physician before immersing in a cold body of water. Children and the extreme elderly should be supervised by a responsible adult.
-  **CAUTION** - Failure to heed the following may result in equipment damage.
 - Maintain proper water chemistry in order to avoid damage to pump, filter, pool shell, etc.
 - Water flow exceeding maximum flow rate requires a bypass. Damage due to excessive water flow will void warranty.

SAVE THESE INSTRUCTIONS

SECTION 3 - INSTALLATION

⚠ WARNING - Failure to heed the following may result in injury or death.

- Installation of this equipment by anyone other than a qualified installer can result in a safety hazard. The information contained throughout the "Installation" section is intended for use by qualified installation technicians familiar with the swimming Pool / Spa safety standards.

⚠ CAUTION - Failure to heed the following may result in equipment damage.

- Failure to protect equipment against corrosive conditions will adversely affect the life of the equipment and will void equipment warranty.

3.1 Dimensions

Dimensions (Great Big Bopper[®])

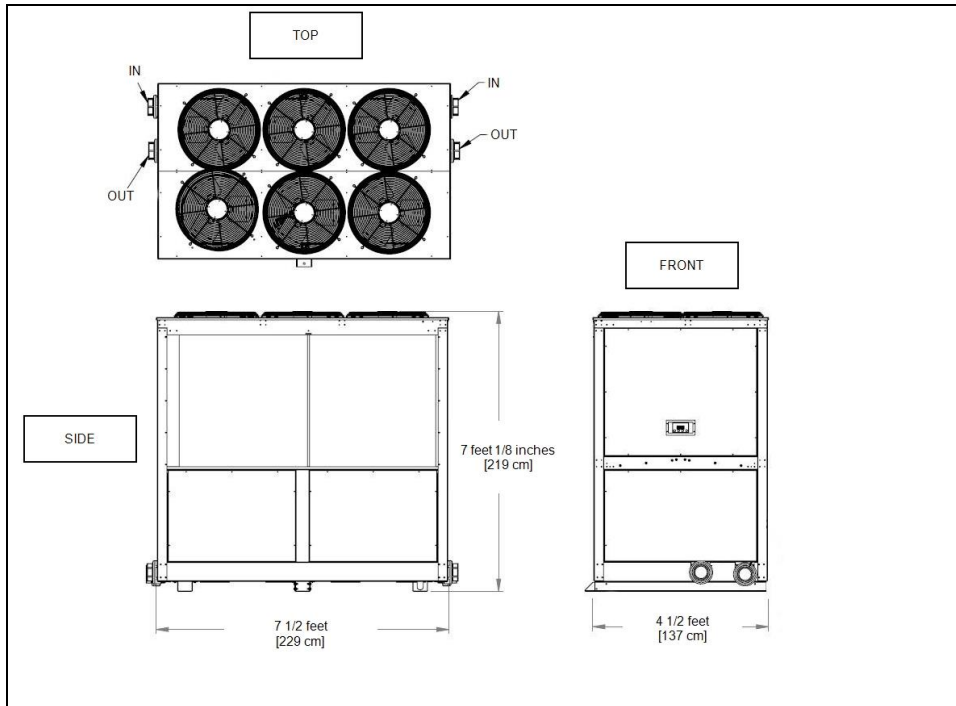

3.2 Positioning Equipment

3.2.a Controlling Irrigation and Rainwater Runoff

- Corrosive irrigation water may damage heat pump components. Have irrigation water directed away from the heat pump.
- The heat pump will withstand normal rainfall. Do not allow a roof slope to direct rainwater onto the heat pump. Have a gutter installed on the roof edge to direct this water away from the heat pump. Or install the heat pump in another location.

3.2.b Planning for Condensation

The heat pump can produce a large amount of water in the form of condensation. The amount of water depends on air temperature and humidity.

- Install the heat pump with enough height to allow for water drainage.
- Use the provided hose connection to direct this water from equipment. This connection is under the lower access panel.
- Plan for water drainage disposal as needed.

3.2.c Mounting Pad Requirements

- Build the heat pump pad out of concrete or another code-approved material.
- Confirm the pad can support the weight of the heat pump. See "Weights" on page 35.
- Elevate the pad enough to allow for drainage.
- Make sure the pad is flat and level.
- Have the pad extend at least 6 inches from the heat pump base in all directions.
- Do not install the heat pump on soil or grass.
- Do not allow the heat pump base to touch the buildings foundation.
- Do not place the heat pump directly on a concrete floor inside a building. This can cause noisy equipment vibration. Install vibration dampeners between the heat pump base and floor.
- Equipment pad must meet all requirements of authorities having code-related jurisdiction.

3.2.d Anchoring to Pad

- Follow all applicable local, state, and national requirements regarding wind load anchoring.
- If needed, contact AquaCal® Customer Support to obtain the correct anchoring kit information. Please have the heat pump model number and serial number when requesting support. See "Identifying Model Specifications" on page 34.

3.3 Plumbing

3.3.a Clearances

- Proper air circulation is required for the heat pump to operate efficiently. Avoid placing objects near or on top of the heat pump. This includes shrubbery and lawn furniture. These objects will also hinder maintenance access.
- Avoid storing chemical containers near the heat pump. The chemicals can cause equipment damage.

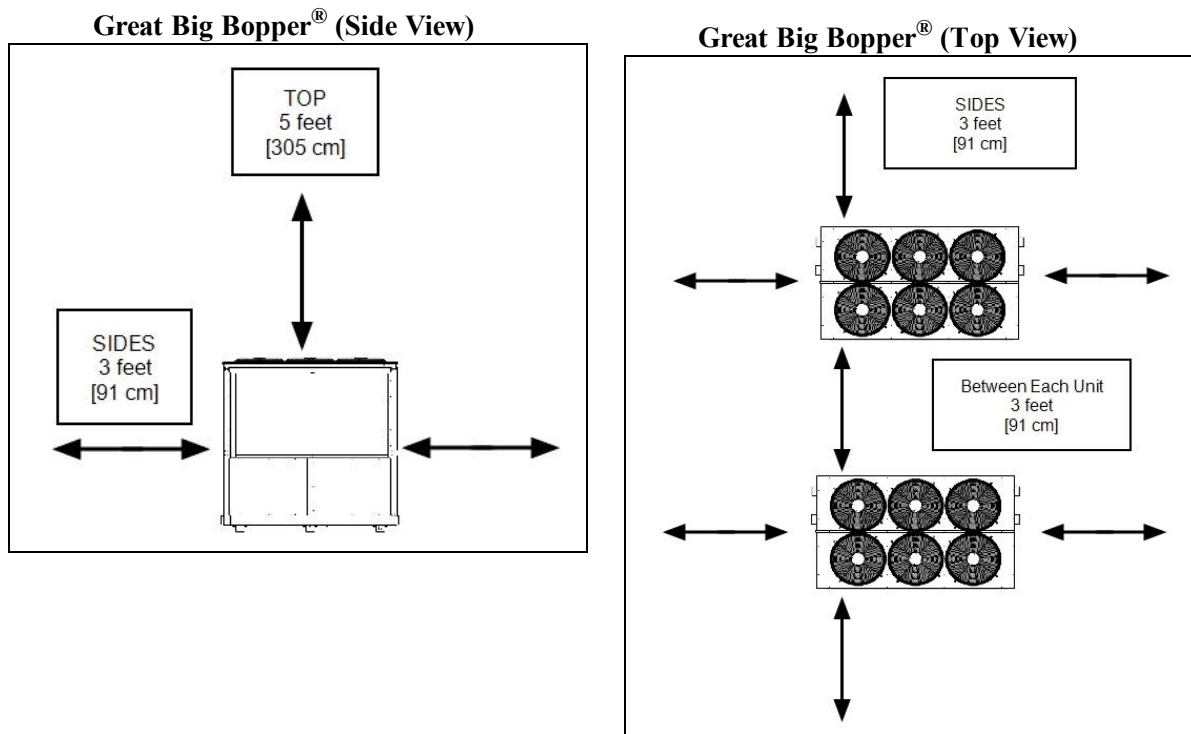

3.3.b Water Flow Rates

Maintain water flow rates as indicated. Please note, these specifications relate to the heat pump only. Code-specified whole system turnover rates must be satisfied.

⚠ CAUTION - Failure to heed the following may result in equipment damage.

- Water flow exceeding maximum flow rate may damage heat exchanger; such damage will not be covered under the equipment warranty

MODEL	HEAT EXCHANGER TYPE	FLOW RATES	
		MINIMUM	MAXIMUM
BB500 50 Hz 380 - 415 V	Titanium ThermoLink [®]	120 GPM	280 GPM
BB500 60 Hz 208 - 230 V	Titanium ThermoLink [®]	120 GPM	280 GPM
BB500 60 Hz 460 V	Titanium ThermoLink [®]	120 GPM	280 GPM

If water flow through the heat pump is reduced, performance will suffer and internal safety devices may deactivate the heat pump with error codes **LP** or **LP5**.

- Operate water filtration devices per manufacturer's specifications. Dirty filters can cause reduced water flow to the heat pump. An increase of 7-10 psi higher than the clean filter pressure typically reduces flow rates. This requires the filter to be cleaned or back-washed
- Keep baskets free of debris. Similar to a dirty filter, large volumes of debris in the pump and skimmer baskets can reduce water flow.
- Check for improper valve settings. A partially closed valve after the filter, or a full-open bypass around the heat pump, will cause insufficient water flow through the heat pump.
- The maximum static (or operating pressure) is 50 pounds-per-square-inch (PSI) unless a special "high-pressure" unit has been ordered. These specifications relate to the heat pump only. Code-specified whole system turnover rates must be satisfied.

3.3.c Adjusting Water Flow Using ΔT (Delta-T)

The Delta-T is the temperature difference between the water temperatures entering and leaving the heat pump. The equipment can be fine-tuned for maximum performance by balancing water flow rates to maintain an ideal ΔT .

- Installed Temperature / Pressure probes and ports are required to perform the following procedures.
- **This adjustment procedure is to be completed with the unit in HEA mode only; ACH and COO discharge temperatures are not shown.**

PLEASE NOTE -

Temperature / Pressure ports are required for all Great Big Bopper[®] installations on both inlet and outlet piping.

1. Adjust heat pump thermostat to its lowest setting while in **HEA** mode.
2. Deactivate the water filtration pump.
3. Adjust valves to a halfway open position leading to the heat pump.
4. Adjust valves to a fully open position leading away from the heat pump.
5. Activate the pool water filtration pump.
6. Slowly turn the thermostat up until the heat pump activates.
 - After a four-minute delay, the heat pump compressor will start.
7. With the heat pump running, confirm water filtration pump is operating properly with adequate flow and no short cycling. If needed, clean filters leading to the heat pump.

**Temperature / Pressure Port
(Shown with Probe)**



8. Wait for water and refrigerant pressure to stabilize (approximately 5 minutes).
9. Adjust valves in the following order:
 - A. Adjust valve leading away from the heat pump to correct temperatures measured with a temperature pressure probe.
 - B. Allow pressure to stabilize . Then check temperature again. Re-adjust valve leading away from the heat pump as needed.
10. Mark valves at these positions for future reference.

Temperature differences are based on pool temperatures of 72° (+ or – 3° F). For water temperatures outside this range, contact AquaCal® Technical Support.

MODEL	TEMPERATURE
BB500 50 Hz 380 - 415 V	3° to 7° F
BB500 60 Hz 208 - 230 V	4° to 8° F
BB500 60 Hz 460 V	4° to 8° F

Table 1 - Temperature Chart

* If unsure what heat exchanger is in equipment, check wintering section for pictures. See "Winterizing" on page 27.

3.3.d Plumbing Requirements

-  **CAUTION** - Failure to heed the following may result in equipment damage.
- Do not use glue on the threaded portion of the equipment's unions. A glued-in-place union will prevent the equipment from being properly winterized.
 - The heat pump must receive water flow within the specified minimum ranges under worst-case conditions such as a fouled water filter. See "Water Flow Rates" on page 3.
 - Water flow exceeding maximum flow rates may damage heat pump and will not be covered under equipment warranty. See "Water Flow Rates" on page 3.
 - Temperature / pressure ports with PVC tees and a test thermometer are also provided in selected models. This must be installed between the unions and the bypass valves. The preferred location of the port is 6" from the heat pump union. See "Adjusting Water Flow Using ΔT (Delta-T)" on page 4.

3.3.e Plumbing Diagrams

Plumbing diagrams are provided in this section as a planning guide to the sequence of equipment, valves, and fittings.

- The basic plumbing configurations for typical installations are shown.
- If the installation does not closely follow any of the supplied plumbing diagrams, AquaCal® Technical Support is available for installation advice and guidance.

Great Big Bopper® Heat Pumps

While multiple Great Big Bopper® heat pumps are shown in the following diagrams, it is not a requirement. Sizing requirements will determine the number of required heat pumps.

Great Big Bopper® Z-Flow Plumbing Design (PREFERRED METHOD)

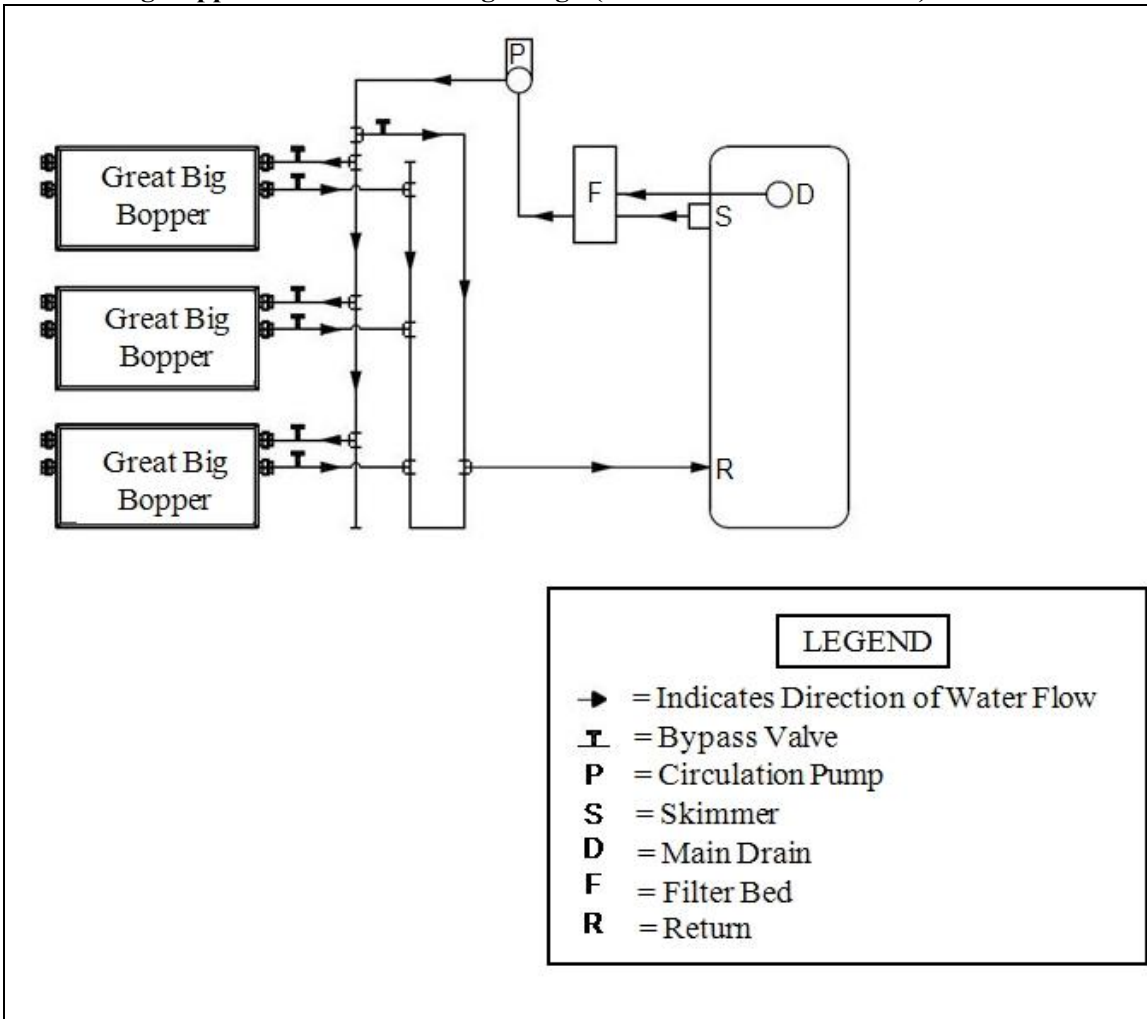

Great Big Bopper® Z-Flow Plumbing Design (PREFERRED METHOD)

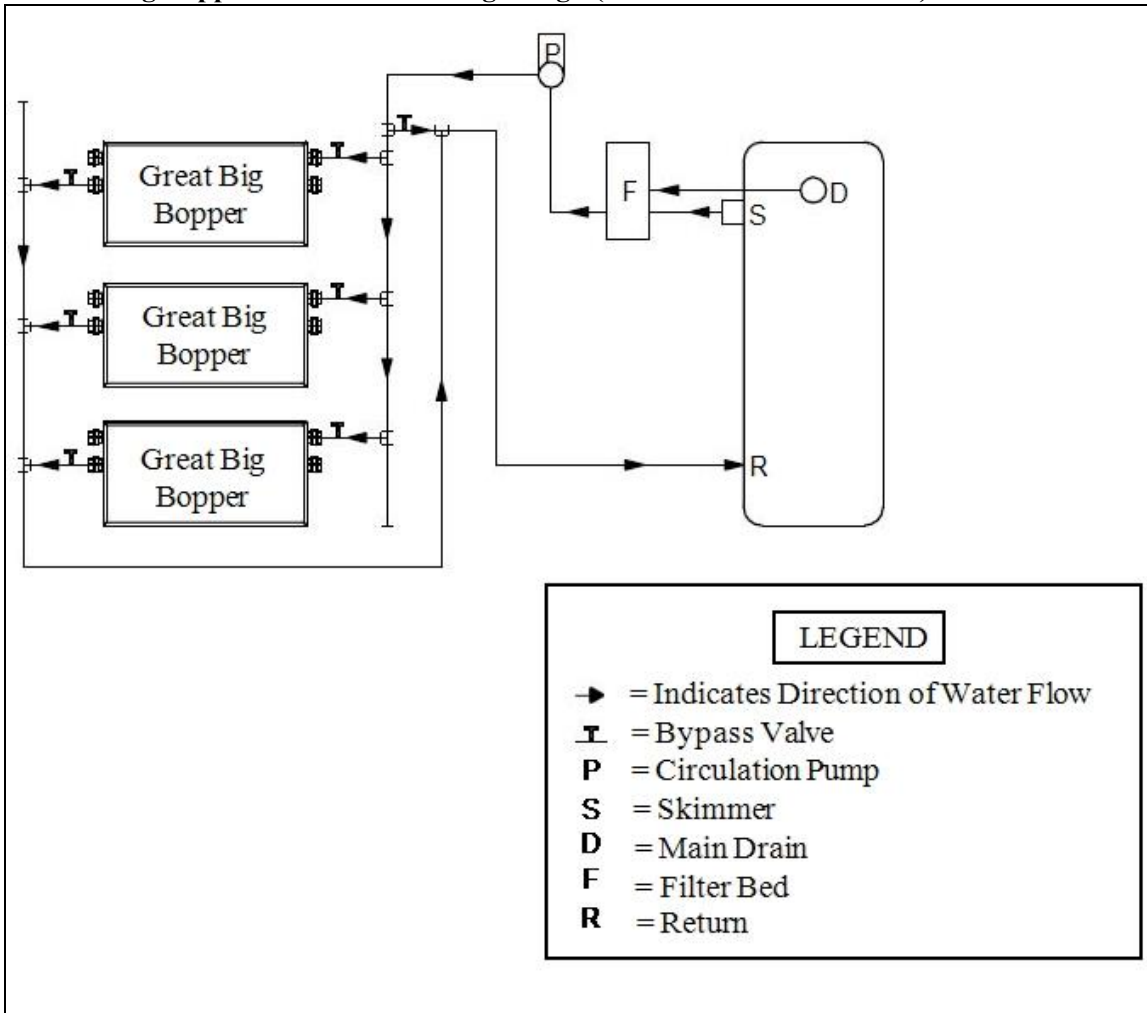

LEGEND

- = Indicates Direction of Water Flow
- I = Bypass Valve
- P = Circulation Pump
- S = Skimmer
- D = Main Drain
- F = Filter Bed
- R = Return

Great Big Bopper® U-Flow Plumbing Design

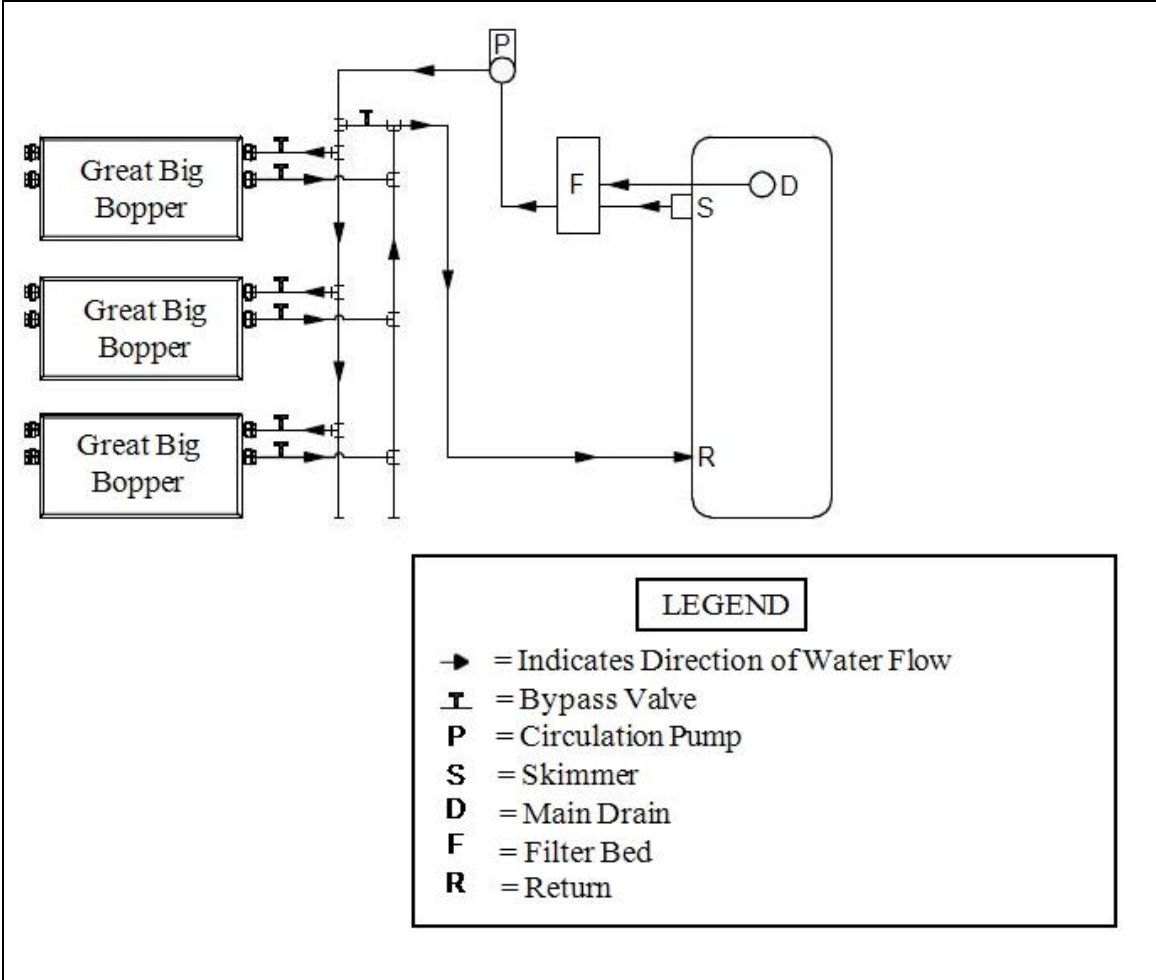

LEGEND	
→	= Indicates Direction of Water Flow
T	= Bypass Valve
P	= Circulation Pump
S	= Skimmer
D	= Main Drain
F	= Filter Bed
R	= Return

Great Big Bopper® U-Flow Plumbing Design

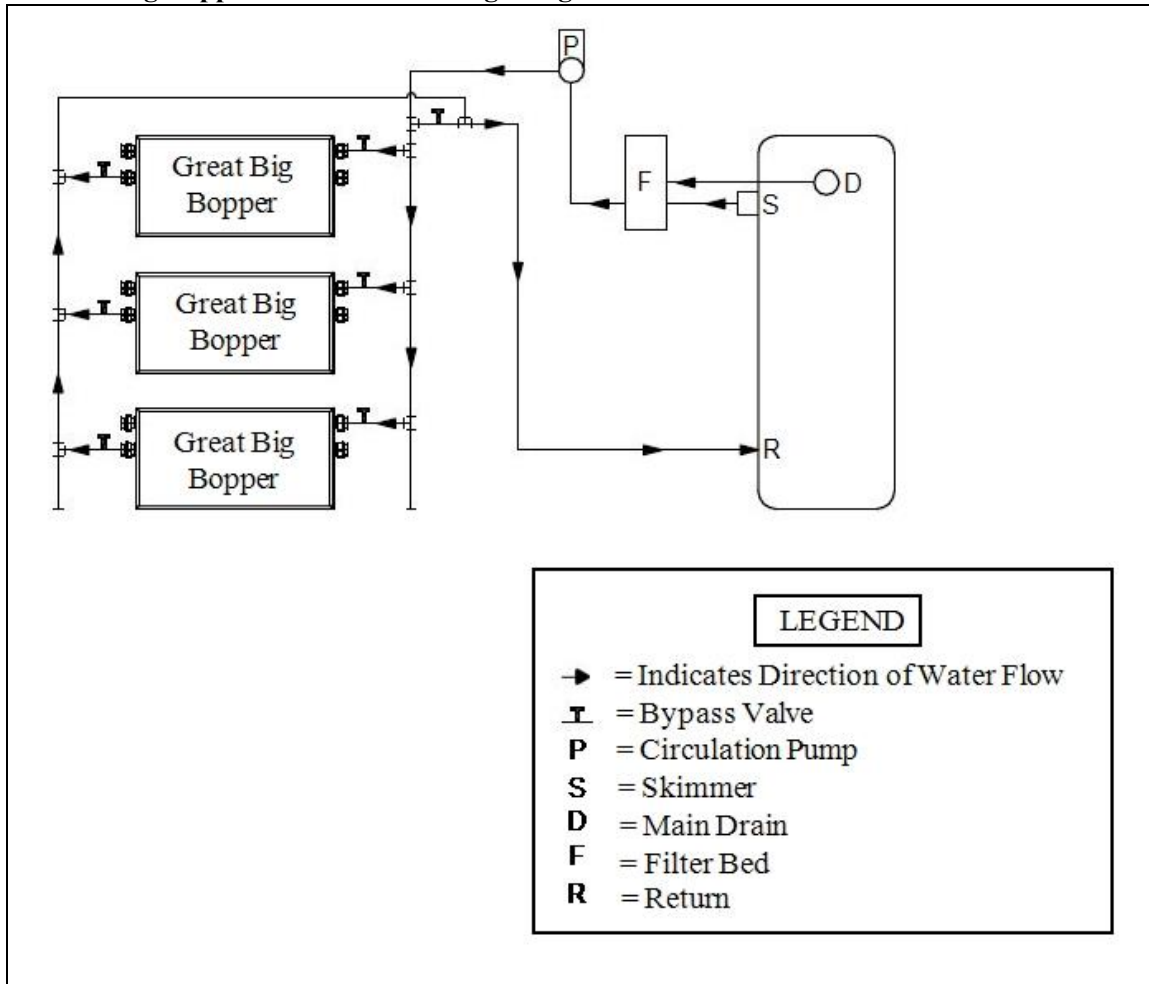

3.3.f Water Connections to Heat Pump

- Connections to site plumbing are made via PVC solvent cement to the female slip socket of the plumbing unions.
- The Heat Pump uses 4-inch union connections.
- These unions are available from AquaCal®. See "Available Accessories" on page 36.

⚠ CAUTION - Failure to heed the following may result in equipment damage.

- Do not use glue on the threaded portion of the equipment's unions. A glued-in-place union will prevent the equipment from being properly winterized.

Great Big Bopper® BB500

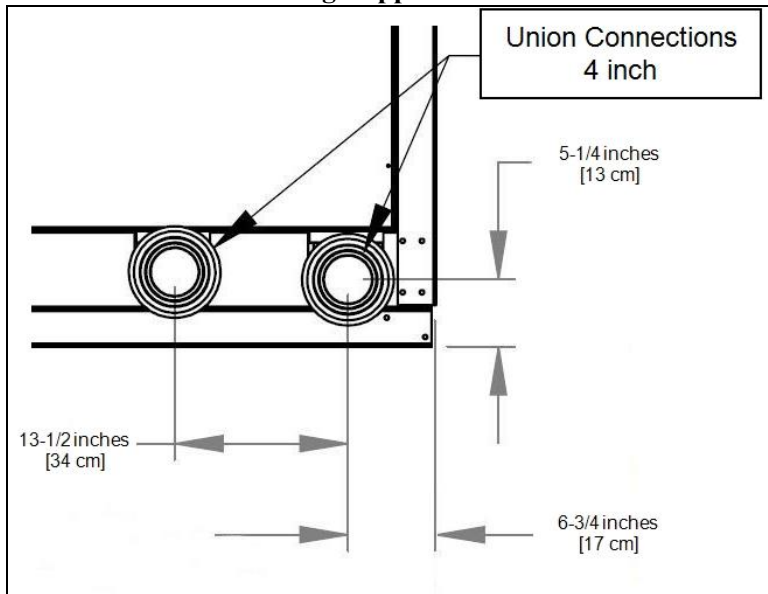

3.3.g In-Line Chlorine Feeders

Place in-line chlorinators downstream from the heat pump and as low in elevation as possible. If an erosion type feeder is used, always install a Hartford Loop to protect internal heat pump components.

3.3.h Maintaining Ability to Winterize

⚠ CAUTION - Failure to heed the following may result in equipment damage.

- Do not use glue on the threaded portion of the equipment's unions. A glued-in-place union will prevent the heat pump from being properly winterized.

The unions can be used to decouple the heat pump from the plumbing system during hard freeze conditions. Do not defeat the function of the unions by using glue on the threaded portion of the unions. See "Winterizing" on page 27.

3.3.i Adjusting Water Pressure Switch

Adjust water pressure switch when heat pump attempts to operate without water flow.

⚠ WARNING - Failure to heed the following may result in injury or death.

- Water Pressure Switch adjustment procedure to be performed by experienced service personnel only; procedure must not be attempted by individuals lacking adequate electrical and mechanical experience.

⚠ CAUTION - Failure to heed the following may result in equipment damage.

- If after water pressure switch adjustment the heat pump continues to operate with the filter pump off, readjust water pressure switch to ensure heat pump will not run without water flow.

Confirm the following before attempting any adjustments:

- The filter is clean.
- Filter pump is operating.
- Valves are set to direct appropriate amount of water through the heat pump. See "Water Flow Rates" on page 3.
- **FLD** code is displayed (or displays intermittently).

Adjusting Water Pressure Switch:

1. Remove heat pump access panel. See "Access Panels" on page 35.
2. Locate the water pressure switch. It will be outside and along the bottom edge of the electrical enclosure. Exact location varies by model.
3. Activate filter pump.
4. Apply power to heat pump.
5. Slowly rotate adjustment wheel on switch until the **FLD** code just disappears.
6. Deactivate filter pump. If correctly adjusted, the heat pump will deactivate and display **FLD**.
7. Re-install heat pump access panel.
 - If heat pump continues to operate without water flow, contact AquaCal® Technical Support.
 - Site-specific factors may require the installation of an external flow switch. See "Available Accessories" on page 36.

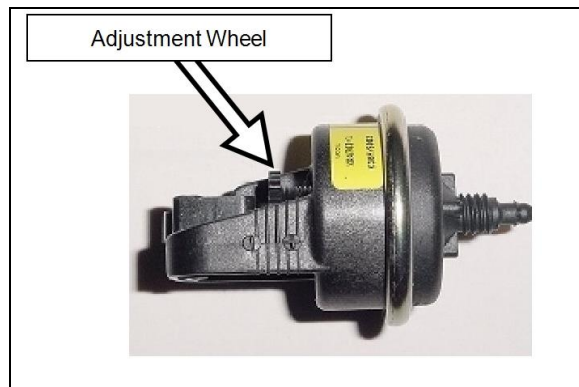

3.4 Electrical

3.4.a Electrical Requirements

- ⚠ WARNING** - Failure to heed the following may result in injury or death.
- The information contained in this section is intended for use by qualified electricians familiar with electrical service-industry safety standards and methods.
 - Locate the equipment disconnect as near to the heat pump as possible. Always satisfy applicable codes and standards.
 - Never mount power-disconnects directly to the heat pump.
 - In sizing power wiring, be especially aware of up-sizing requirements necessary due to wiring distances. Always satisfy applicable codes and standards.
 - Multiple heat pumps installed at the same site may benefit from automatic sequencing controllers (ASC) to avoid excessive power drops at start-up. See "Available Accessories" on page 36.
 - AquaCal® heat pumps are designed for copper conductors, only. Do not use aluminum wire.

3.4.b Electrical Standards

Standards	Title
NFPA 70	The electrical installation must conform to the current version of the NEC, and all applicable local and state codes
NFPA 70 Article 440	Standard for Safety for Electric Spas, Equipment Assemblies, and Associated Equipment
NFPA 70 Article 680	Standard for Safety for Swimming Pool Pumps, Filters, and Chlorinators
IEC 60335-1-2001	Household and similar electrical appliances - Safety - General Requirements
IEC 60335-2-40 2006	Household and similar electrical appliances - Safety – Particular requirements for electrical heat pumps, air-conditioners, and dehumidifiers
UL1995 & CSA C22.2 236-05	Heating and cooling equipment

Table 2 - Standards

3.4.c Grounding and Bonding

Follow local code requirements for properly grounding and bonding heat pump equipment.

3.4.d Surge Suppression

The use of approved commercial surge protectors is strongly recommended.

3.4.e Sizing the Electrical Service

Refer to equipment data plate for specific information required to size electrical service and over-current protection of heat pump. Sizing is based on data plate information, wire size, wiring devices, and over-current protection per applicable local codes and standards. See "Identifying Model Specifications" on page 34.

3.4.f Schematics

Schematics are located on the inside of the equipment access panel. Some schematics have been included in this appendix.

PLEASE NOTE:

- Specifications are subject to change without notice.
- Schematics are available by calling AquaCal® Customer Support.
 - Please have the complete model and serial number available.
 - See "Identifying Model Specifications" on page 34.

Schematic Document Numbers Chart		
Phase	Equipment Model Numbers	Schematic #
Three	GBB	LTM0214

3.4.g Verifying Transformer Setting

Transformer voltage settings must be confirmed and set correctly depending on the measured voltage found on the site. Incorrect settings may cause heat pump damage. The following procedure will allow the installer to set the heat pumps transformer for the appropriate site voltage.

⚠ WARNING - Failure to heed the following may result in injury or death.

- The information contained in this section is intended for use by qualified electrical installation technicians, familiar with electrical service-industry safety standards and methods.

⚠ CAUTION - Failure to heed the following may result in equipment damage.

1. Turn heat pump on by adjusting the thermostat to call for heat. If more than one heat pump is on site, turn them all on. Final adjustments must be made with all heat pumps running.
2. Measure the running site voltage.
3. Confirm transformer tap is set for the measured site voltage. If more than one voltage tap is shown, select the voltage nearest to the running site voltage.

**Example of heat pump transformer
(Varies between models)**

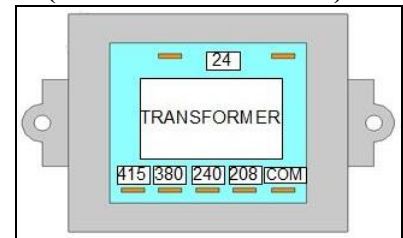

Please note: If more than one voltage is shown on the equipment's data plate, the factory default setting is the higher listed voltage. As an example, a "208 / 230" voltage will be set to "230" from the factory.

4. If a heat pump is using three-phase incoming power, confirm voltage and settings are correctly set at the monitor. See "Three-Phase Adjustment" on page 13.

3.4.h Three-Phase Adjustment

- If a three-phase unit fails to operate at start up, the orientation of the line voltage "field" wiring may need to be adjusted.
- Units equipped with the ICM Digital Three-Phase Monitor will display a "Back Phase Rev" fault code. There is no display on the standard three-phase monitor.
- Three-phase models may be equipped with a Standard Three-Phase Monitor (**Figure 1**) or the ICM Digital Three-Phase Monitor (**Figure 2**).

⚠ WARNING - Failure to heed the following may result in injury or death.

- The information contained in this section is intended for use by qualified electrical installation technicians, familiar with electrical service-industry safety standards and methods.

⚠ CAUTION - Failure to heed the following may result in equipment damage.

- Setting a voltage other than what is listed on the heat pump's data plate can damage equipment and is not covered under warranty.
1. Deactivate power to the unit. **Confirm that power is off to all three legs using an electrical test meter set for the correct voltage.**
 2. Switch position of the incoming power wires at each leg as follows, re-connect power, and attempt to restart the unit. If the unit fails to start, disconnect power. Verify off and proceed to next leg.
 - Switch incoming power wires at L1 and L2 on the line side to the contactor.
 - Switch incoming power wires at L1 and L3 on the line side to the contactor.
 - Switch incoming power wires at L2 and L3 on the line side to the contactor.
 3. When heat pump starts, disconnect power and verify off. Then confirm all line voltage connections are securely tightened. Reconnect power.
 - If heat pump does not start, contact AquaCal® Technical Support.

Standard Three-Phase Monitor



Figure 1

ICM Digital Three-Phase Monitor



Figure 2

3.5 Connecting Heat Pump to an External Controller

External Controllers

To support a direct connection to an external controller, AquaCal® heat pumps are equipped with option terminal blocks. These terminals are on the microprocessor located on the low-voltage side of the electrical enclosure.

⚠ WARNING - Failure to heed the following may result in injury or death.

- This section is only for qualified installers who are familiar with swimming pool and spa safety standards.
- The installer must be familiar with service industry techniques.
- Deactivate power while routing wiring to control board.

⚠ CAUTION - Failure to heed the following may result in equipment damage.

- The wire size connecting the controller must be 16-gauge, 2-conductor, or larger low-voltage wire.
- Use direct connection (**dry contact**) provided on the microprocessor for external controllers.

Connections to Heat Pump

Please confirm the type of external controller to be installed and follow the appropriate instructions.

- A **two-wire** controller (**with an internal thermostat**). *The user can set and adjust the temperature at the controller's screen.*
- A **three-wire** controller (**with an "OFF" position**). *The user adjusts the temperature at the heat pump. The user can select pool or spa mode or turn off the heat pump using the controller.*
- A **three-wire** controller (**without an "OFF" position**). *The user adjusts the temperature at the heat pump. The user can select pool or spa mode, but must turn off the heat pump at the heat pump control panel.*

Two-wire controller (with internal thermostat):

1. Deactivate power to heat pump.
2. Remove heat pump electrical access panel.
3. Route the control wiring to the low voltage side of the electrical enclosure. Follow all National Electric Codes (NEC) unless State or Local guidelines supersede.
4. Connect the controller wires to the microprocessor as follows:
 - Connect one wire to "Y". See Figure 3.
 - Connect other wire to "Z".
 - The polarity of the wire is not important.
5. Reattach heat pump access panel.
6. Apply power to heat pump.

Dry Contact Connection Points to the Microprocessor

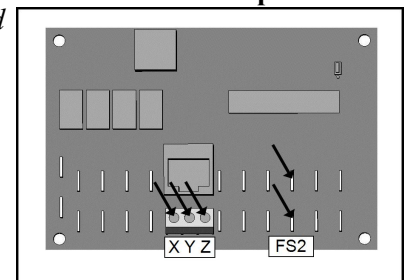

Figure 3

7. Program heat pump for a two-wire controller. See "Programming for External Controller - using JAO interface" on page 16.
8. Test external controller. See "Operating Heat Pump (With an External Controller)" on page 24.

Three-wire controller (with "OFF" position):

1. Deactivate power to heat pump.
2. Remove heat pump electrical access panel.
3. Route the control wiring to the low voltage side of the electrical enclosure. Follow all National Electric Codes (NEC) unless State or Local guidelines supersede.
4. Connect the controller wires to the microprocessor as follows:
 - Connect "High" or "Spa" wire to "X". See Figure 3.
 - Connect "Common" wire to "Y".
 - Connect "Low" or "Pool" wire to "Z".
5. Reattach heat pump access panel.
6. Apply power to heat pump.
7. Program heat pump for a three-wire controller. See "Programming for External Controller - using JAO interface" on page 16.
8. Test external controller. See "Operating Heat Pump (With an External Controller)" on page 24.

Three-wire controller (without an "OFF" position):

1. Deactivate power to heat pump.
2. Remove heat pump electrical access panel.
3. Route the control wiring to the low voltage side of the electrical enclosure. Follow all National Electric Codes (NEC) unless State or Local guidelines supersede.
4. Connect the controller wires to the microprocessor as follows:
 - Connect "Common" wire to one terminal of "FS2". See Figure 3.
 - Connect "Spa" to other terminal of "FS2".
 - The third wire is not used.
5. Reattach heat pump access panel.
6. Apply power to heat pump.
7. Program heat pump for an external controller. See "Programming for External Controller - using FS2 interface" on page 16.
8. Test external controller. See "Operating Heat Pump (With an External Controller)" on page 24.

Programming for External Controller - using JAO interface

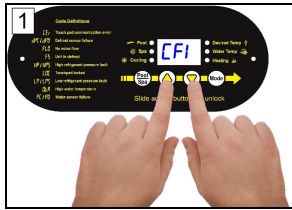

Press "Up" and "Down" buttons simultaneously until **CF 1** appears.

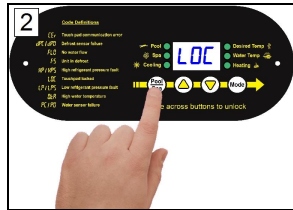

Press "Pool / Spa" button until **LOC** is displayed.

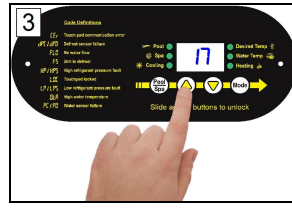

Press "Up" or "Down" to passcode. Default is "17".

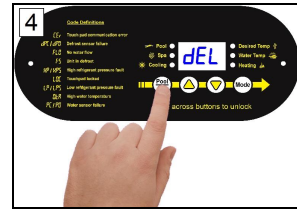

Press "Pool / Spa" button once.

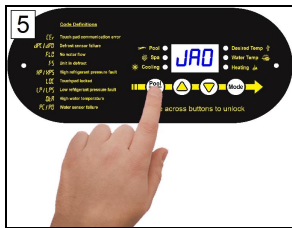

Press the "Pool / Spa" button until **JAO** is displayed.

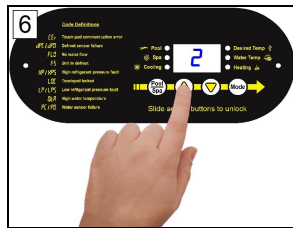

Press "Up" or "Down" button.

- "0" - none
- "2" - two-wire
- "3" - three-wire

Programming for External Controller - using FS2 interface



Press "Up" and "Down" buttons simultaneously until **CF 1** appears.

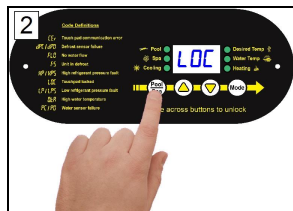

Press "Pool / Spa" button until **LOC** is displayed.

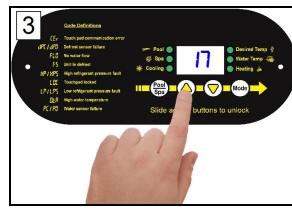

Press "Up" or "Down" to passcode. Default is "17".



Press "Pool / Spa" button once.

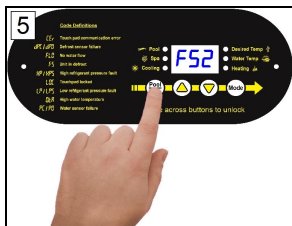

Press the "Pool / Spa" button until **FS2** is displayed.

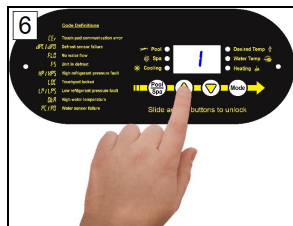

Press "Up" or "Down" button.

- "0" - none
- "1" - External

3.6 Programming

 CAUTION - Failure to heed the following may result in equipment damage.

- Service Level Programming must only be attempted by authorized service personnel.
- Unauthorized adjustments in the Service Menu (beyond the **LOC** menu) may void the heat pump's warranty.
- For further assistance, please contact AquaCal® Technical Support. See "Contacting AquaCal AutoPilot, Inc." on page 1.
- The compressor time delay should only be deactivated for diagnostic convenience, and must be reactivated prior to placing heat pump back in service. Failure to reset time delay could result in permanent damage to the heat pump compressor.
- Resetting the microprocessor to access a locked keypad will reset all settings to factory default including any installer-entered configuration. Re-programming all custom site condition settings will be required when using this reset. See "Reset to Factory Defaults Settings" on page 19.

PLEASE NOTE -

Before changing multiple program options, it is recommended to disable the user lock option. The lockout option can be re-enabled after all changes are completed.

3.6.a Factory Defaults

Certain programming options have been preset at the factory. These options can be overwritten for certain site-specific conditions.

CODE	DESCRIPTION	DEFAULT VALUE	RANGE
CFD	Call-Flex Options	0	Set to off at the factory.
dbP	Pool Dead-Band Differential	1°	Set at Factory. Do not adjust.
dbS	Spa Dead-Band Differential	1°	Set at Factory. Do not adjust.
dEL	Compressor Time Delay	1 (4 minutes)	0 = "OFF" 1 = "ON"
dSC	Defrost Sensor	Factory Calibrated	Set at Factory. Do not adjust.
dFd	Defrost Delay	Factory Calibrated	Set at Factory. Do not adjust.

CODE	DESCRIPTION	DEFAULT VALUE	RANGE
F52	Flow Switch / Auto T-Stat Switching Option	0	0 = "No Switch" 1 = "Enable Switch"
JAO	External Controller	0	0 = "No Controller" 2 = "Two Wire Controller" 3 = "Three Wire Controller"
LOC	Service Entry Point	50	00 - 99
t5C	Water Sensor	Factory Calibrated	Set at Factory. Do not adjust.

Table 3 - Default Program Parameters Chart

3.6.b Deactivate Time Delay

The time delay should only be deactivated by qualified HVAC technicians for diagnostic convenience, and must be re-activated prior to placing heat pump back in service. Failure to reset time delay feature could result in permanent damage to the compressor.

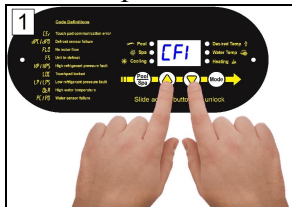

Press "Up" and "Down" buttons simultaneously until **CF 1** appears.



Press "Pool / Spa" button until **LOC** is displayed.

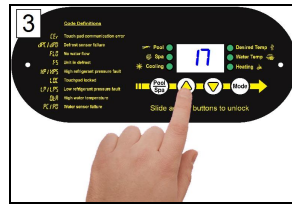

Press "Up" or "Down" to passcode. Default is "17".



Press "Pool / Spa" button once.



Press "POOL / SPA" button until **dEL** is displayed.

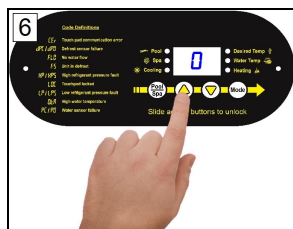

Press the "UP" or "DOWN" button

- "0" - disable
- "1" - activate

3.6.c Reset to Factory Defaults Settings

! CAUTION - Failure to heed the following may result in equipment damage.

- Using this option will reset **ALL** settings to their factory defaults including external controller settings and sensor calibrations. **DO NOT** perform this operation if unsure of site specific settings or how to reset them on the heat pump.
- If a qualified technician is unavailable, please contact AquaCal® Technical Support. See "Contacting AquaCal AutoPilot, Inc." on page 1.

1. Simultaneously Press "Pool / Spa" button and "Up" button until the display shows **888**.
2. Release buttons. Reset is complete.

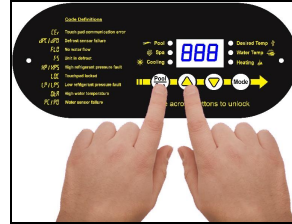

SECTION 4 - OPERATION

4.1 Energizing Heat Pump

Turn power on at external fuse box or breaker disconnect.

- Controller performs a lamp test.
- The display reads **888**.
- Controller then displays as normal. See "Display" on page 20.

4.2 Display Lock

The heat pump has a display lock to protect against inadvertent setting changes. To activate display and controls, slide finger across the controls as shown from left to right.

- The code **UnL** will briefly appear, then the set temperature or mode will display.
- This is different than a user-lock which requires a pass code. See "User Lock Option (Enable)" on page 22.

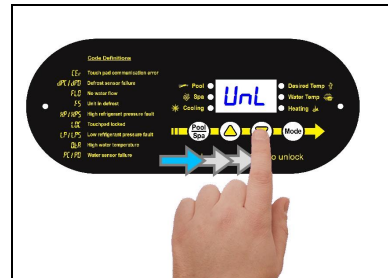

4.3 Control Panel

The following information outlines the operation for a standard installation.

- Control Buttons will operate differently for custom installations; such as a heat pump connected to an external controller. See "Operating Heat Pump (With an External Controller)" on page 24.

Control Panel

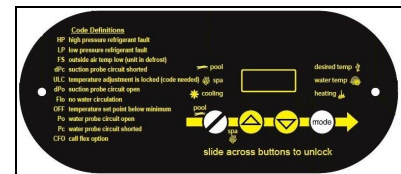

4.4 Buttons

Buttons	Description
Display Lock	Sliding your finger across the buttons from left to right will temporarily disable the display lock.
Pool / Spa	Select either the pool or the spa thermostat.
Up Arrow	Used to increase temperature set point and navigate through menu options.
Down Arrow	Used to decrease temperature set point and navigate through menu options.
Mode	Select heat pump's operating mode.

4.5 Indicator Lights

Indicators	Description
Pool	The Heat Pump is referencing the pool thermostat.
Spa	The Heat Pump is referencing the spa thermostat.
Heating	Indicates the unit is heating the water. Please note - the compressor must be operating before this light will illuminate.
Cooling	Indicates the unit is cooling the water. Please note - the compressor must be operating before this light will illuminate.
Water Temp	Indicates current water temperature.
Desired Temp	Indicates temperature set point is displayed. This is displayed when "UP" or "DOWN" is selected.

4.6 Display

Display	Description
75	The heat pump is on and displaying the current water temperature. In this example 75° F is displayed.
FLO	No water flow is detected. The filter pump is off or heat pump is not receiving correct water flow.
OFF	The heat pump has been turned off via the mode selector button or the temperature set point has been lowered below 45° F.
888	The control program is initializing. This displays only as power is applied to the heat pump. The program version number will then be displayed.

Display	Description
<i>CF 1</i>	Select water temperature format (in either Celsius or Fahrenheit).
<i>ULC</i>	Enable heat pump lockout feature.
<i>ELC</i>	Select passcode to lock the keyboard.
<i>LOC</i>	This is a Service Entry Point (not intended for use by the owner). The <i>LOC</i> code permits service personnel to enter a factory passcode to access adjustable calibration and site dependent setup parameters. Service adjustments are available to authorized installation and service personnel, only.

4.7 Factory Defaults

Certain programming options have been preset at the factory. These options can be overwritten for site-specific conditions.

⚠ CAUTION - Failure to heed the following may result in equipment damage.

- Service Level Programming must only be attempted by authorized service centers.
- Unauthorized adjustments in the Service Menu (beyond the *LOC* menu) may void heat pump's warranty.
- If the issue reoccurs, please contact AquaCal® Technical Support. See "Contacting AquaCal AutoPilot, Inc." on page 1.

Table 4 - Factory Defaults

CODE	DESCRIPTION	DEFAULT VALUE	RANGE
<i>OFF</i>	Heat Pump is deactivated.	<i>OFF</i>	
<i>HEA</i>	Set to heat water to point set on thermostat.		
<i>COO</i>	Set to cool water to point set on thermostat.		
<i>ACH</i>	Set to maintain a water temperature set on the thermostat.		
<i>CF 1</i>	Celsius / Fahrenheit Selection	1	0 = Celsius 1 = Fahrenheit
<i>ELC</i>	Enter Lock Code	0	0 - 99
<i>ULC</i>	User Lock Code	0	0 = "User Lock Disabled" 1 = "User Lock Enabled"

4.8 Setting Operating Mode

Heat Mode



Cool Mode

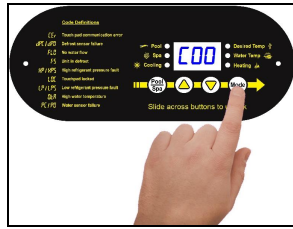

Automatic Heat / Cool Mode



Deactivate Heat Pump

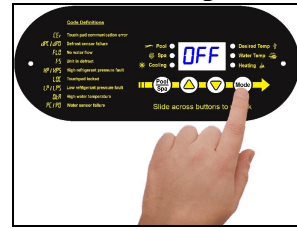

Heating / Cooling modes only available on select equipment. Confirm heat pump features before setting a mode.

4.9 Setting Thermostats

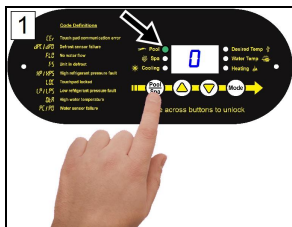

Select "POOL" or "SPA"

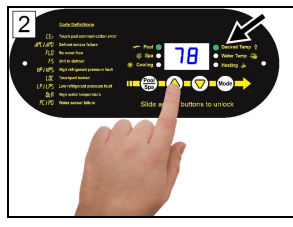

Press "UP" or "DOWN" to the desired temperature.

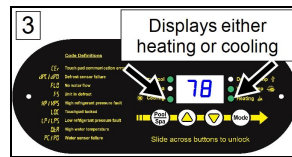

- The heating indicator will illuminate when heating the water.
- The cooling indicator will illuminate when cooling the water.

4.10 Selecting Celsius or Fahrenheit



Hold "UP" and "DOWN" until "CF" displays.

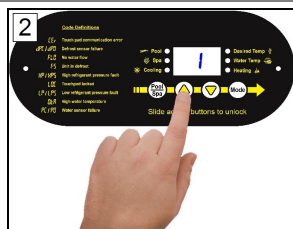

"0" - Celsius
"1" - Fahrenheit

4.11 User Lock Option (Enable)

The user-lock feature allows the heat pump control panel to be "locked"; preventing unauthorized temperature adjustments.

- Do not confuse a user-lock with the display lock. See "Display Lock" on page 19.
- If **LDC** is briefly displayed, followed by a "0", the heat pump is already locked.



Hold "UP" and "DOWN" until **CFI** displays.



Press "POOL / SPA" button until **ELC** is displayed.

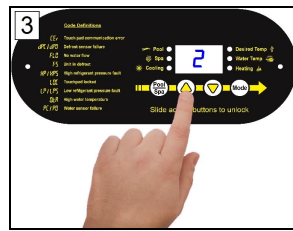

Press "UP or "DOWN" button to change or add a numerical password

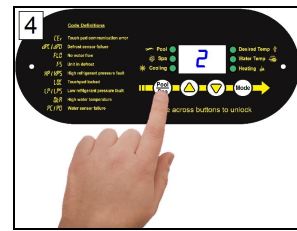

Press "POOL / SPA" button to lock in the password.



Press "POOL / SPA" button until **ULC** is displayed.

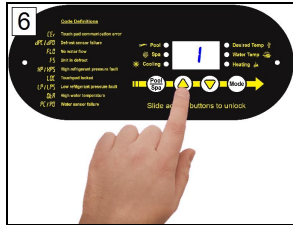

Press "Up" button till "1" is displayed to enable.

4.12 User Lock Option (Entering Pass Code)

If **LOC** is briefly displayed when attempting to change a heat pump's settings followed by a "0", the heat pump is in a user-lock mode. A numerical passcode is required to proceed.

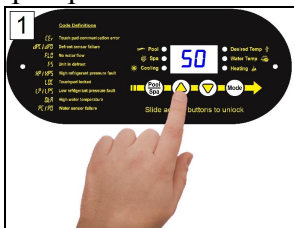

Press "UP" or "DOWN" arrow to enter user lock code.

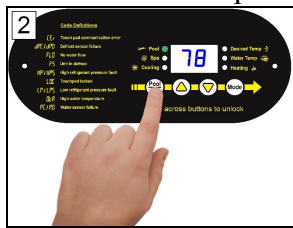

Press "POOL / SPA" button again to unlock.

NOTE -

- After three seconds of inactivity, the heat pump's slide lock will activate.
- If the user-lock code has been misplaced, the heat pump must be reset to default factory settings. See "Reset to Factory Defaults Settings" on page 19.

4.13 User Lock Option (Disable)

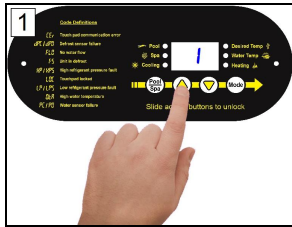

Use "UP" button to enter existing password.

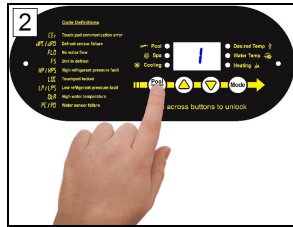

Press "Pool / Spa" button to unlock.



Hold "UP" and "DOWN" buttons until **CF 1** is displayed.

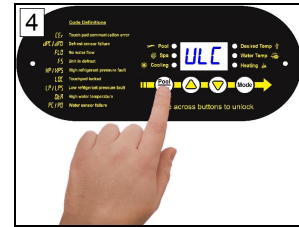

Press "POOL / SPA" button until **ULL** is displayed

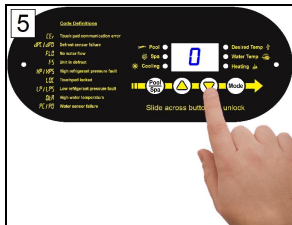

Press "DOWN" button until "0" is displayed.

4.14 Operating Heat Pump (With an External Controller)

Controller with an internal thermostat control

Activating Heat Pump

1. Set the desired temperature at the external controller.
2. Use the external controller to select either the "Pool" or "Spa" to heat.

Deactivating Heat Pump

- Set the external controller to "OFF".

Please note - If equipped, the heat pump's cooling function **will be disabled** when using this type of controller.

If the cooling function is needed, the heat pump must be temporarily re-programmed for local control.

- Set the heat pump to operate with external control temporarily set to "none".
- See "Programming for External Controller - using JAO interface" on page 16.
- It is ok to leave external controller wires in place while the heat pump is set for local control.

Controller with 2 positions - ("Pool" and "Spa" - no internal thermostat control)

Activating Heat Pump

1. Set the desired temperatures on the heat pump thermostats. See "Setting Thermostats" on page 22.
2. Use the external controller to select either the "Pool" or "Spa" to heat.
 - *Rapid movement between thermostats without a "rest" between each change can cause a missed signal by the heat pump.*

Deactivating Heat Pump

- Go to the heat pump and set the mode to "OFF". See "Setting Operating Mode" on page 22.

Please note - If equipped, the heat pump's cooling function **will be disabled** when using this type of controller.

If the cooling function is needed, the heat pump must be temporarily re-programmed for local control.

- Set the heat pump to operate with external control temporarily set to "none".
- See "Programming for External Controller - using JAO interface" on page 16.
- It is ok to leave external controller wires in place while the heat pump is set for local control.

Controller with 3 positions - ("High", "Low", and "Off" - no internal thermostat control):

Activating Heat Pump

1. Set the desired temperatures on the heat pump thermostats. See "Setting Thermostats" on page 22.
2. Use the external controller to select either "High" or "Low" to heat.
 - *When changing between thermostats, select "Off" first. Then select desired thermostat.*
 - *Rapid movement between thermostats without a "rest" between each change can cause a missed signal by the heat pump.*

Deactivating Heat Pump

- Set the external controller to "OFF".

SECTION 5 - MAINTENANCE

5.1 Water Chemistry

Check water chemistry regularly and maintain within recommended levels. Standards for commercial applications vary in different areas. Follow all local applicable codes.

⚠ CAUTION - Failure to heed the following may result in equipment damage.

- Do not allow water to flow through heat pump when refinishing or acid washing a pool. Either use an installed bypass to route water away from heat pump or deactivate filter pump.
- To avoid damage to equipment, monitor and maintain chemistry within recommended levels.

CHEMISTRY LEVEL CHART (RESIDENTIAL)		
CHEMICAL	POOLS	SPAS
Chlorine	1.0 – 3.0 ppm	3.0 – 5.0 ppm
Bromine	2.0 – 6.0 ppm	2.0 – 6.0 ppm
Cyanuric Acid	30 - 50 ppm	30 - 50 ppm
pH	7.4 – 7.6 ppm	7.4 – 7.6 ppm

CHEMISTRY LEVEL CHART (RESIDENTIAL)		
CHEMICAL	POOLS	SPAS
Total Alkalinity	80 – 120 ppm	80 – 120 ppm
Calcium Hardness	200 – 400 ppm	150 – 250 ppm
Total Dissolved Solids*	0 – 1,500 ppm	1,500 ppm above start-up total dissolved solids in spas

* Salt from a chlorine generator is not included in Total Dissolved Solids.

5.2 Cleaning Equipment After Installation

Installer - If you need to clean equipment after installation, please use the following guidelines.

- ⚠ WARNING** - Failure to heed the following may result in injury or death.
- Possible electric shock hazard - Deactivate power to all electrical devices on the pad when washing heat pump. Do not restore electrical power until equipment is completely dry.

- ⚠ CAUTION** - Failure to heed the following may result in equipment damage.
- Do not use a pressure cleaner to wash heat pump. Damage to heat pump components may result. If using a hose-end spray nozzle adjust spray pattern to low strength only.
 - Do not spray water directly into the interior of the heat pump; damage to components may result.
 - Do not use chemicals on the control panel.

Cleaning

1. Wash outside cabinet using a low-pressure water hose. A high-pressure water stream will cause damage to the aluminum fins of the heat pump. This damage is not covered under product warranty.
2. While the heat pump is still wet, use an approved cleaning agent to clean the exterior of the heat pump. **Do not use chemicals on the control panel.**
3. Use a detergent-dampened cloth to wipe the heat pump's exterior cabinet.
4. Flush all exterior with fresh water using a low-pressure water hose.
5. Dry the exterior cabinet using a soft cloth being careful not to damage evaporator fins.

APPROVED CLEANING AGENTS*
Fantastic®
Formula 409®
Cascade®
All Power Plain Detergent (3% Solution)

Table 5 - Cleaning Agents

Polishing

1. Polish the heat pump's cabinet panels using an approved polishing agent and following the manufacturer's instructions. Do not use chemicals on the control panel.
2. Rinse the heat pump panels with fresh water, wipe, and buff panels using a dry soft cloth.
3. Allow heat pump interior and surrounding equipment to "air-dry" for several hours prior to restoring electrical power.

APPROVED POLISHING AGENTS*
Simoniz [®] Wax
AeroWax [®]
Glo-Coat [®]
Armor All [®] Protectant

Table 6 - Polishing Agents

* The trademarks used in approved cleaning and polishing agents are property of their owners and are not related to AquaCal[®].

5.3 Winterizing

- ⚠ WARNING** - Failure to heed the following may result in injury or death.
 - Deactivate all electrical power to heat pump before performing hard freeze procedures.
- ⚠ CAUTION** - Failure to heed the following may result in equipment damage.
 - Failure to winterize heat pump may result in serious equipment damage. Freeze damage is not covered under the heat pump warranty.
 - While the plumbing connections are in the winterized condition (not fully tightened), it is imperative the pool and spa water not be circulated through the heat pump. Loss of water through loose plumbing connections may result in damage to circulating pump, pool and spa structures, and other equipment.

Light Freeze Conditions

There are two freeze conditions requiring heat pump attention. A light freeze is when the ambient air temperature falls below 32 degrees Fahrenheit for less than 8 hours. Typically during light freeze conditions circulating (moving) water will not freeze. Override time clocks and allow filtration system to run continuously during light freeze conditions.

Hard Freeze Conditions

A hard freeze is when the ambient air temperature falls below 32 degrees Fahrenheit for more than 8 hours. In areas where this condition is prevalent and sustained, the heat pump **MUST** be winterized for hard freeze conditions. Follow the correct procedure depending on the type of heat exchanger found in the heat pump.

Identify Exchanger:

1. Deactivate all electrical power to heat pump.
2. Deactivate filter pump.
3. Remove front access panel.
4. Identify heat pump exchanger from illustrations in this section. Then follow procedure for that heat pump's exchanger.

Titanium ThermoLink® Exchanger (with Internal Drain)

1. Disconnect the plumbing to the heat pump at connection unions (removal is counter-clockwise).
2. Remove internal drain plug.
3. Allow water to drain completely from the heat pump. Expect to see a lot of water drain out at first, and then a small amount to continue to drain out over a long period.
4. After heat pump is fully drained, re-connect internal drain plug and reinstall front access panel.
5. Partially reconnect plumbing connection unions.
6. Winterizing is complete.
7. When ready to use heat pump again, hand-tighten connection unions. Reconnect electrical power, and set the operating mode on the heat pump. Activate filter pump.

**Internal
Drain**

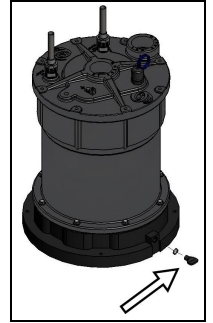

Titanium ThermoLink® Exchanger (with no Drain)

1. Reinstall front access panel.
2. Disconnect the plumbing to the heat pump at connection unions (removal is counter-clockwise).
3. Allow water to drain completely from the heat pump. Expect to see a lot of water drain out at first, and then a small amount to continue to drain out over a long period.
4. After heat pump is fully drained, reinstall front access panel.
5. Partially reconnect plumbing connection unions.
6. Winterizing is complete.
7. When ready to use heat pump again, hand-tighten connection unions. Reconnect electrical power, and set the operating mode on the heat pump. Activate filter pump.

No Drain



SECTION 6 - TROUBLESHOOTING

6.1 Fault Codes

A fault code indicates a specific issue or condition that will require action before the equipment can resume operating.

Please perform the following troubleshooting.
If the issue reoccurs, please contact AquaCal® Technical Support. See "Contacting AquaCal AutoPilot, Inc." on page 1.

- ⚠ WARNING** - Failure to heed the following may result in injury or death.
- Repairs must not be attempted by untrained or unqualified individuals.
 - The heat pump contains refrigerant under high pressure. Repairs to the refrigerant circuit must not be attempted by untrained or unqualified individuals. Service must be performed only by qualified HVAC technicians. Recover refrigerant before opening the system.
- ⚠ CAUTION** - Failure to heed the following may result in equipment damage.
- Service by unauthorized personnel will void the heat pump warranty.

FLO Indicator

ISSUE

Low or no water detected.

RESOLUTION

1. Confirm the filter pump is on.
2. If a multiple-speed filter pump is being used, run at a higher speed to determine if the error persists. Do not exceed maximum flow rate for your model.
3. Confirm water is not being diverted away from the heat pump.
 - See "Water Flow Rates" on page 3.
 - See "Adjusting Water Flow Using ΔT (Delta-T)" on page 4.

CEr Indicator

ISSUE

This can indicate a loose or damaged communication cable.

RESOLUTION

A qualified technician should check the cable from control board to display assembly for a loose connection or visible damage.

CSE Indicator

ISSUE

This is a control system error.

RESOLUTION

1. Deactivate then reactivate power to reset controls.
2. If the issue reoccurs, please contact AquaCal® Technical Support. See "Contacting AquaCal AutoPilot, Inc." on page 1.

dPC or dPD Indicator

ISSUE

Shorted or open defrost sensor.

RESOLUTION

A qualified technician should replace the defrost sensor.

PC or PD Indicator

ISSUE

Shorted or open water sensor.

RESOLUTION

A qualified technician should replace the defrost sensor.

HP Indicator

ISSUE

The refrigerant system's high-pressure switch is showing as open.

RESOLUTION

1. Determine if an insufficient amount of water is being supplied to the equipment.
 - a. Confirm the filter pump is on.
 - b. If a multiple-speed filter pump is being used, run filter pump at a higher speed. Do not exceed maximum flow rate for your model.
 - c. Confirm water is not being diverted away from the heat pump.
 - See "Water Flow Rates" on page 3.
 - See "Adjusting Water Flow Using ΔT (Delta-T)" on page 4.
2. If the issue reoccurs, please contact AquaCal® Technical Support. See "Contacting AquaCal AutoPilot, Inc." on page 1.

HP5 Indicator

ISSUE

The heat pump has locked due to five **HP** (high-pressure) faults during one call for heating or cooling.

RESOLUTION

1. Deactivate then reactivate power to the heat pump to clear error.
2. Troubleshoot the high-pressure issue causing the error. See "HP Indicator" on page 30.
3. If the issue reoccurs, please contact AquaCal® Technical Support. See "Contacting AquaCal AutoPilot, Inc." on page 1.

LP Indicator

ISSUE

The refrigerant system's low-pressure switch is showing as open.

RESOLUTION

If the heat pump is a reversing unit, place it in **HEA** mode and perform the following troubleshooting.

1. Check for obstructed air flow around the heater. See "Clearances" on page 3.
2. Check for dirty or blocked evaporator coil. See "Cleaning Equipment After Installation" on page 26.
3. Check for signs of ice buildup on the coil.
4. For further assistance, please contact AquaCal® Technical Support. See "Contacting AquaCal AutoPilot, Inc." on page 1.

LP5 Indicator

ISSUE

The heat pump has locked due to five **LP** (low-pressure) faults during one call for heating or cooling.

RESOLUTION

1. Deactivate then reactivate power to the heat pump to clear error.
2. Troubleshoot the low-pressure issue causing the error. See "LP Indicator" on page 30.

OEI Indicator

ISSUE

Incoming water temperature exceeded 110° F and the unit is locked with an **OEI** over temperature alarm. The heat pump will not operate until incoming water temperature drops to 100° F or lower.

RESOLUTION

1. Determine if another heat source (gas heater, solar heater, etc.) is heating water being sent directly to the heat pump with the **OEI** indicator. This situation will need to be corrected before continuing.
2. Rule out an incorrect reading from the water temperature sensor. Verify existing water temperature with an accurate thermometer. If heat pump's sensor is inaccurate, the water temperature sensor may require replacement.

6.2 Issues and Resolutions

⚠ WARNING - Failure to heed the following may result in injury or death.

- Repairs must not be attempted by untrained or unqualified individuals.
- The heat pump contains refrigerant under pressure. Repairs to the refrigerant circuit must not be attempted by untrained or unqualified individuals. Service must be performed only by qualified HVAC technicians. Recover refrigerant before opening the system.

⚠ CAUTION - Failure to heed the following may result in equipment damage.

- Service by unauthorized personnel will void the factory warranty.

Please perform the following troubleshooting.
For further assistance, please contact AquaCal® Technical Support. See "Contacting AquaCal AutoPilot, Inc." on page 1.

Control Panel Not Responding

1. If the heat pump is controlled by an external controller, confirm the external controller settings. See "Operating Heat Pump (With an External Controller)" on page 1.
2. If the issue is still occurring, disconnect external controller from the heat pump.
 - Then check operation at heat pump.
 - If control panel responds, the problem lies with the external controller or its installation. Contact the manufacturer of the external control device.
3. For further assistance, please contact AquaCal® Technical Support. See "Contacting AquaCal AutoPilot, Inc." on page 1.

Heat Pumps Not Running

1. Confirm equipment is receiving power. Is the heat pump display illuminated?
 - If not, confirm the main breaker (located at the power supply panel) and the disconnect switch (located near the heat pump) are both turned on.
 - If the display still does not illuminate, it is recommended that the heat pump installer or electrician confirms heat pump is receiving power.
2. Confirm correct mode is selected. See "Setting Operating Mode" on page 22.
3. Confirm thermostat is set correctly. See "Setting Thermostats" on page 22.
 - If heating the water, the thermostat should be set above the current water temperature.
 - If cooling the water, the thermostat should be set below the current water temperature.
4. If an error code is displayed, diagnose and correct the cause of the code. See "Fault Codes" on page 28.
5. If the heat pump is using an external controller, the heat pump may not be set correctly to accept the controller's signal.
 - See "External Controllers" on page 14.
 - See "Operating Heat Pump (With an External Controller)" on page 24.
6. For further assistance, please contact AquaCal® Technical Support. See "Contacting AquaCal AutoPilot, Inc." on page 1.

Heat Pumps Tripping Breaker

1. Have an electrician confirm breakers are in good condition and properly sized for the heat pump.
2. Multiple heat pumps installed at the same site may benefit from special automatic sequencing controllers to avoid excessive power drops at start-up. See "Automatic Sequencing Controller" on page 36.
3. If a fault occurs immediately when the compressor starts, a qualified technician should evaluate the system.

Heat Pump Won't Shut Off

1. If the heat pump is using an external controller, it may not be set correctly to accept the controller's signal.
 - See "Programming for External Controller - using JAO interface" on page 16.
 - See "Programming for External Controller - using FS2 interface" on page 16.
 - Determine if the external controller has its own thermostat. If yes, heat pump mode must be set to **OFF**.

Heat Pump Is Running, Not Heating

1. Confirm heat pump mode is set to either **HEA** or **ACH**.
2. Confirm heat pump is on and transferring heat into the water.
 - Measure the temperature of air discharge coming out of heat pump fan. If discharge air is between 8° to 10° colder than the outside ambient air (entering air), then the heat pump is moving heat into the water.
3. Confirm thermostat is set to the desired water temperature.
4. If the heat pump is using an external controller, confirm it is set correctly to accept the controller's signal.
 - See "Connections to Heat Pump" on page 14.
 - If the heat pump is still not running correctly with this device, contact the installer of the external controller device or the device's manufacturer for further assistance.
5. If an error code is displayed, diagnose and correct cause of code. See "Fault Codes" on page 28.
6. Confirm valves are correctly positioned to heat the correct body of water (either the pool or the spa). If heating a spa that overflows into a pool, confirm the spa is isolated when being heated (not flowing into the pool).
7. Confirm that filter pump has a sufficient run-time. The heat pump will not run (or heat the water) without water flow. Great Big Bopper® equipment will generally be set to run 24 hours a day in commercial applications. See "Initial Heating Recommendations" on page 35.
8. If heating a spa, deactivate air blower or venturi (if equipped) to allow for quicker heating times. For pools, deactivate water features, such as slides, waterfalls, or fountains to allow water to retain heat. Use of a liquid pool blanket product, such as an Aqua Blanket™, can also compensate for excessive heat loss.

Heat Pump Is Running, Not Cooling (Reversing Models)

1. Confirm the heat pump mode is set to either **COO** or **ACH** operating mode.
2. Confirm the thermostat is set below the current water temperature.
3. Confirm heat pump is transferring heat out of the water.
 - Measure the temperature of air discharge coming out of heat pump fan. If discharge air is between 8° to 10° warmer than outside ambient air (not coming out of heat pump), then the heat pump is moving heat out of the water.
4. If an error code is displayed, determine and correct the condition causing the code. See "Fault Codes" on page 28.
5. Confirm valves are correctly positioned to cool the correct body of water (either the pool or the spa). If cooling a spa that overflows into a pool, confirm the spa is isolated when being cooled (not flowing into the pool).
6. Confirm that filter pump has a sufficient run-time. The heat pump will not run (or cool the water) without water flow. Great Big Bopper® equipment will generally be set to run 24 hours a day in commercial applications. See "Initial Cooling Recommendations" on page 35.

Water Coming From Heat Pump

The water may be normal condensation produced as a by-product of the heat pump's refrigeration process. The heat pump can produce 8 to 10 gallons of condensation per day depending on the humidity of the ambient air. Determine if the water is condensation or a possible leak.

1. If using chlorine or bromine as a pool / spa sanitizer, use a test strip in the water at heat pump to determine if sanitizer is present. If sanitizer is present, a leak may exist.
2. Deactivate heat pump, leaving the filter pump on. After several hours, determine if water is still coming from the heat pump.
3. If the issue reoccurs, please contact AquaCal® Technical Support. See "Contacting AquaCal AutoPilot, Inc." on page 1.

SECTION 7 - APPENDIX

7.1 Identifying Model Specifications

1. Find Data Plate - The data plate is usually posted on the side of the equipment or on the control panel access plate.
2. Find the model number on the data plate. The first letters and numbers indicate the model type.
3. The complete model number identifies the equipment's specifications.

Data Plate Example

MINIMUM CIRCUIT AMPACITY	<input type="text"/>	MADE IN THE USA
ELEC. SERVICE: VOLTS	<input type="text"/>	PH <input type="text"/> HZ <input type="text"/>
MAXIMUM TIME DELAY FUSE OR HACR BREAKER <input type="text"/> 5		
COMPRESSOR VOLTS	R.L.A. <input type="text"/>	L.R.A. <input type="text"/>
FAN MOTOR VOLTS	H.P. <input type="text"/>	F.L.A. <input type="text"/>
REFRIGERANT: Circuit - Factory charged <input type="checkbox"/> Only oz/Kg <input type="text"/>		
Tested to <input type="checkbox"/> psig High side / <input type="checkbox"/> psig Low side		
AQUA CAL, INC A TEAM HORNER COMPANY 2737 24 TH STREET NORTH ST. PETERSBURG, FL 33713 FACTORY SERVICE 727-523-5642		MODEL NUMBER <input type="text"/> IIIBAR CODEIII SERIAL NUMBER <input type="text"/> IIIBAR CODEIII

Model Number Example

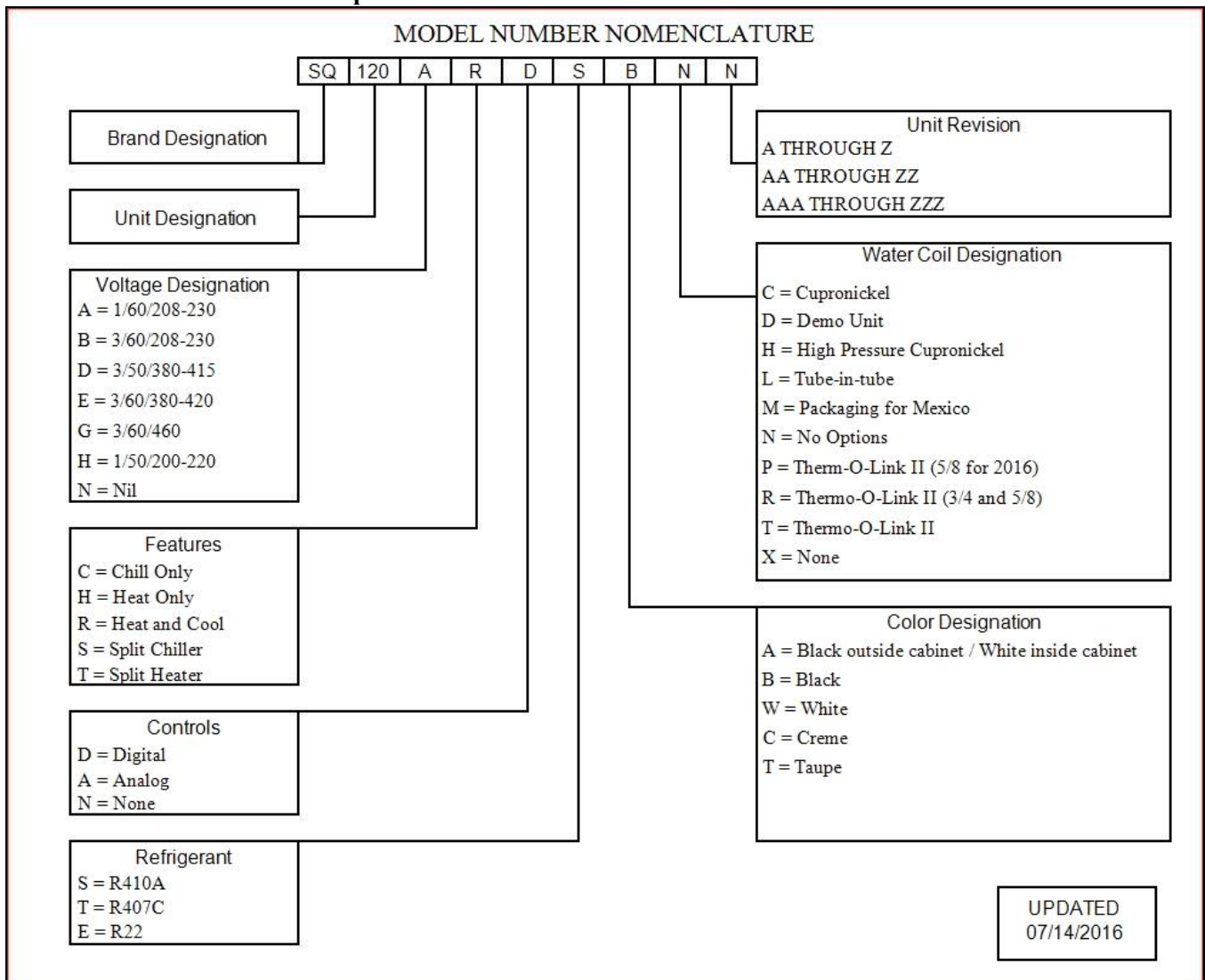

7.6 Available Accessories

Automatic Sequencing Controller

- An Automatic Sequencing Controller (ASC) provides easy control of all units from one lead unit and prevents the simultaneous start-up of multiple heat pumps.
- Site voltage drop is minimized and utilities are not subjected to large in-rush demands of electrical current.
- Part number is based on number of heat pump's to be controlled. Call AquaCal® Customer Support for assistance with correct configuration.

External Flow Relay (Grid Flow) Switch Kit (0040s)

- Used when the pool / spa elevation is higher than the heat pump.
- Used when a variable two-speed filter pump set on low-speed mode does not provide enough water pressure to activate a heat pump's water pressure switch.
- Also used for automatic pool / spa thermostat switching.

Remote Control Kit (STK0070)

- A remote (wired) control kit allows for full control of the heat pump from up to 100 feet from the equipment.

Plumbing Unions:

SIZE	PART NUMBER
4 INCH	PLP0081

7.7 Schematics

Schematics are located on the inside of the equipment access panel.
Some schematics have been included in this appendix.

PLEASE NOTE:

- Specifications are subject to change without notice.
- Schematics are available by calling AquaCal® Customer Support.
 - Please have the complete model and serial number available.
 - See "Identifying Model Specifications" on page 34.

Schematic Document Numbers Chart		
Phase	Equipment Model Numbers	Schematic #
Three	GBB	LTM0214

