

PoolSync™

Owner's / Installation Manual



Important!

This manual covers the installation and operation of the PoolSync™ device.

Read this manual and product labels before installing or operating this equipment.

INSTALLER: This document is the Purchaser's property and is to remain with the equipment owner.

Table of Contents

Safety Information

Safety Information	1
--------------------------	---

General Information

Contacting AquaCal AutoPilot, Inc.	2
How Your PoolSync™ Works	2

Control Panel Overview

User Display	3
Reset Button LED	3
Service Mode Button LED	3
Service Access and Setup Button LED's	3

Installation

Wiring to a PoolSync™ Ready Device	4
ChlorSync™ Wiring	4
AquaCal® Heat Pump Wiring	6
ChlorSync™ and AquaCal® Heat Pump Combination	8
Downloading the PoolSync™ App	10
Connect the PoolSync™ to the WiFi	10
Discover Connected Equipment	10
Mounting the PoolSync™	10

Troubleshooting

Troubleshooting	11
-----------------------	----

Reference

FCC Compliance	12
----------------------	----

SAFETY INFORMATION

Safety Information

IMPORTANT SAFETY INSTRUCTIONS

When installing and using this electrical equipment, basic safety precautions should always be followed, including the following:

READ AND FOLLOW ALL INSTRUCTIONS

- Follow all state provincial and NEC (National Electrical Codes) and applicable CEC (Canadian Electrical Codes) unless local guidelines supersede.
- For personal safety, and to avoid damage to equipment, follow all safety instructions displayed on the equipment and within this manual.
- Should you suspect your unit is not performing properly, refer to the Troubleshooting section in this manual to determine if service is required.
- Warranties will be voided if the PoolSync™ has been improperly installed. Failure to properly operate, maintain or repair the PoolSync™ will void the factory warranty.

SAFETY SIGNALS

Throughout this manual, safety signals are placed where particular attention is required.



WARNING - Failure to heed the following may result in permanent injury or death.



CAUTION - Failure to heed the following may result in equipment damage.



WARNING - Failure to heed the following may result in permanent injury or death.

- **RISK OF ELECTRICAL SHOCK** - Disconnect all AC power when installing or servicing this system. Follow all state, local, and National Electrical Codes (provincial and Canadian Electrical Code(s) if applicable). Use copper conductors only.
- **RISK OF ELECTRICAL SHOCK** - This product must be installed and serviced by a contractor who is licensed and qualified in pool equipment. Before installing this product, read and follow all warnings that accompany this product .
- **PERSONAL SAFETY HAZARD** – Failure to follow warning notices and instructions may result in personal injury or death.

SAVE THESE INSTRUCTIONS

GENERAL INFORMATION

Contacting AquaCal AutoPilot, Inc.

If you need to call AquaCal AutoPilot, Inc. for questions, service, or parts, please have your model and serial number of the equipment being controlled by the PoolSync™ available. Also have the name of your installer and date of your equipment's installation. Please refer to our website for the latest manual revisions, additional information, and helpful service advice.

Website	www.autopilot.com
Phone	(727) 823-5642
Fax	(877) 408-8142
Address	AquaCal AutoPilot, Inc. 2737 24th Street North St. Petersburg, FL 33713, USA

How Your PoolSync™ Works

The PoolSync™ is a communication device that allows the user to view and control PoolSync™ Ready devices via the PoolSync™ downloadable iOS or Android app.

The device is connected to the PoolSync™ Ready equipment by a four wire connection using an RS485 protocol.

When paired with the PoolSync™ device, advanced functionality and control of the PoolSync™ Ready equipment will be available.

The ChlorSync™ chlorinator:

- View current salt level and water temperature
- See how much salt to add, when needed
- Receive a notification when the cell needs to be cleaned
- Be alerted should the unit need attention
- Change the chlorine output percentage

The AquaCal® heat pump:

- View current water temperature
- Change setpoint temperature
- Change heat pump schedule (only when circulation pumps are operating)

CONTROL PANEL OVERVIEW

User Display

PoolSync™ Label

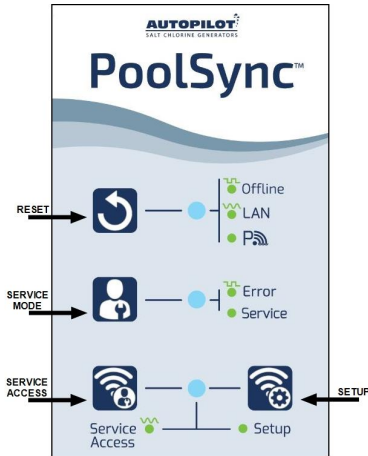

Figure 1

Reset Button LED

Pressing this button will allow the PoolSync™ to be reset.

- **Blinking:** Indicates the PoolSync™ unit is Offline and not connected to the network.
- **Fading:** Indicates the PoolSync™ is connected to the local home router.
- **Solid:** Indicates the PoolSync™ is connected to the Cloud.

Service Mode Button LED

Indicates the unit is in Service Mode.

- **Blinking:** Indicates there may be a communication error.
- **Solid:** Indicates your system is being serviced and user control is disabled.

Service Access and Setup Button LED's

- **Fading:** This will allow a service technician to use the PoolSync™ as an access point when setting up all PoolSync™ Ready equipment.
- **Solid:** Indicates the unit is in setup mode and ready to be connected to the home network.

INSTALLATION



WARNING - Failure to heed the following may result in permanent injury or death.

- **RISK OF ELECTRICAL SHOCK** - Disconnect all AC power when installing or servicing this system. Follow all state, local, and National Electrical Code (s) (provincial and Canadian Electrical Code(s) if applicable). Use copper conductors only.
- **RISK OF ELECTRICAL SHOCK** - All electrical connections should be made by a licensed electrician or certified electrical contractor.



CAUTION - Failure to heed the following may result in equipment damage.

- Improper wiring will cause damage to the equipment. Damage resulting from improper wiring will void the unit's warranty.
- Failure to follow instructions may result in property damage. The PoolSync™ must be installed and operated as specified. Failure to do so will void the equipment warranty.

Wiring to a PoolSync™ Ready Device

The unit is equipped with a four-conductor cable that will connect to your PoolSync™ Ready pool equipment. The correct wiring sequence must be followed to ensure your unit will communicate with the PoolSync™ Ready products.

ChlorSync™ Wiring

1. Turn off power to the ChlorSync™ unit.
2. Remove the power center cover and unfasten the grommet in one of the available openings on the bottom of the box.
3. Insert the strain relief that was provided with the PoolSync™ device. Route the antenna wire through the strain relief and into the power center.
4. There is one (1) - four position connector and two (2) - two position connectors located on the front of the board for wiring RS485 (antenna wire) devices. Remove the four (4) position connector by pulling up on the black plastic body.
5. Once disconnected and the retaining screws are fully loosened, connect the stripped end of the PoolSync™ wires as per the wiring indications provided on the silkscreen of the PCB. See the diagram on the following page.
6. Verify the wires are firmly held in place by gently pulling on the wire and ensure it remains connected.
7. Once wires are connected, replace the connector onto the PCB header pins. Be sure to align correctly.
8. Tighten the strain relief, replace the power center cover and restore power to the unit.

- Black wire from PoolSync™ to BLK (or GND)
- Yellow or White wire from PoolSync™ to YEL (or A)
- Green wire from PoolSync™ to GRN (or B)
- Red wire from PoolSync™ to RED (10v)

PoolSync™ Wiring

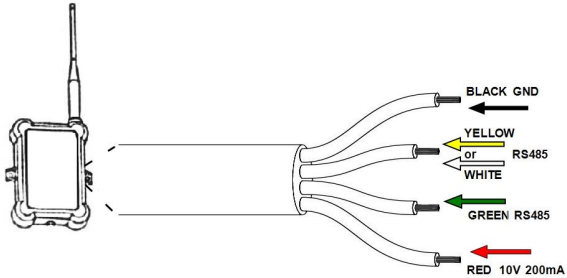

Figure 2

ChlorSync™ Wiring

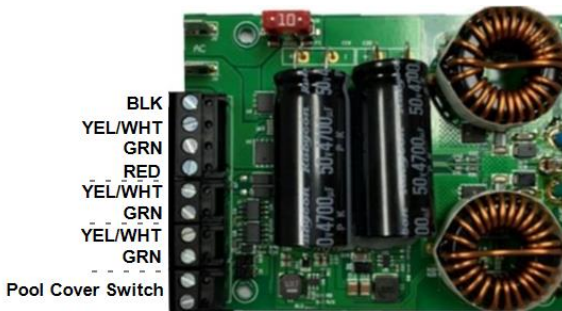

Figure 3

Note: Before mounting the PoolSync™, verify WiFi reception.

AquaCal® Heat Pump Wiring



WARNING - Failure to heed the following may result in permanent injury or death.

- RISK OF ELECTRICAL SHOCK - Disconnect all AC power when installing or servicing this system. Follow all state, local, and National Electrical Code (provincial and Canadian Electrical Code(s) if applicable). Use copper conductors only.
 - RISK OF ELECTRICAL SHOCK - All electrical connections should be made by a licensed electrician or certified electrical contractor.
 - RISK OF ELECTRICAL SHOCK - Risk of electrical shock from energy stored in capacitors - Models equipped with variable frequency compressor drives store electricity even after the power has been deactivated at the power breaker. **Wait for 2 minutes after the shut down of equipment before servicing.**
 - RISK OF ELECTRICAL SHOCK - Only qualified professionals who are familiar with the swimming pool and spa safety standards should service this unit. The installer must be familiar with service industry techniques.
1. Turn off all power to the heat pump. **Wait for 2 minutes after the shut down of equipment before servicing.**
 2. Open the pool heater front cabinet to expose the electrical access panel and control board.
 3. Locate Port D on the HP9 control board. Confirm you have the correct port by removing the four-pin connector. The port identification will be silk screened on the PCB.
 4. Connect the wires as per the guide and diagram on the following page.
 5. Verify the wires are firmly held in place by gently pulling on the wire and ensure it remains connected.
 6. Once wires are connected, replace the connector onto the PCB header pins. Be sure to align correctly.

PoolSync™ Wiring

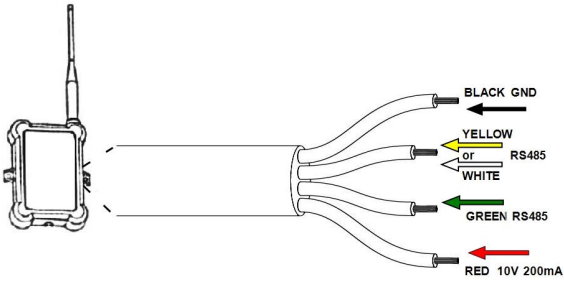

Figure 4

- Black wire from PoolSync™ to G (or GND)
- Yellow or White wire from PoolSync™ to Y (or A)
- Green wire from PoolSync™ to B
- Red wire from PoolSync™ to R (or 10v)

Port D



Figure 5

Port D Wire Location

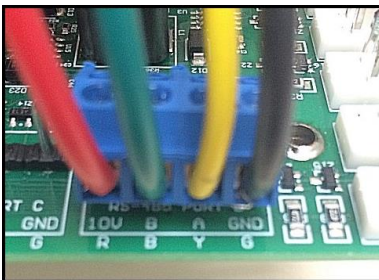

Figure 6

Note: Before mounting the PoolSync™, verify WiFi reception.

ChlorSync™ and AquaCal® Heat Pump Combination

You can control and monitor both the ChlorSync™ chlorinator and the AquaCal® pool heat pump using one PoolSync™ device. Choose which unit you wish to connect the device to and follow the wiring instructions below.



CAUTION - Failure to heed the following may result in equipment damage.

- Do not connect two RED wires in the same port. This may cause damage to the equipment. Damage resulting from improper wiring will void the unit's warranty.
- Failure to follow instructions may result in property damage. The PoolSync™ must be installed and operated as specified. Failure to do so will void the equipment warranty.

For the ChlorSync™:

1. Follow the directions shown previously to connect the PoolSync™ to the ChlorSync™.
2. Once wires are connected, thread a separate four-conductor cable (22 AWG) through the other available opening at the bottom of the ChlorSync™ power supply. Using a strain relief to secure the wire is recommended.
3. Attach the wires to the four-pin connector as per below:
 - Black wire from PoolSync™ to G (or GND)
 - Yellow or White wire from PoolSync™ to Y (or A)
 - Green wire from PoolSync™ to GRN (or B)
 - **DO NOT ATTACH THE RED WIRE. This will damage the equipment. Apply a cap to that wire.**
4. Verify the wires are firmly held in place by gently pulling on the wire and ensure it remains connected.
5. Once wires are connected, replace the connector onto the PCB header pins. Be sure to align correctly.
6. Tighten the strain relief and replace the power center cover.
7. Connect the other end of the wire to Port D on the heater PCB as per below:
 - Black wire from PoolSync™ to G (or GND)
 - Yellow or White wire from PoolSync™ to Y (or A)
 - Green wire from PoolSync™ to B
 - **DO NOT ATTACH THE RED WIRE. This will damage the equipment. Apply a cap to that wire.**
8. Once wires are connected, replace the connector onto the PCB header pins. Be sure to align correctly. Close the cover and restore power

For the AquaCal® heater:

1. Follow the directions shown previously to connect the PoolSync™ to the AquaCal® heater.
2. Use a separate four-conductor cable (22 AWG) and connect the wires to Port D as per below:
 - Black wire from PoolSync™ to G (or GND)
 - Yellow or White wire from PoolSync™ to Y (or A)
 - Green wire from PoolSync™ to B
 - **DO NOT ATTACH THE RED WIRE. This will damage the equipment. Apply a cap to that wire.**
3. Verify the wires are firmly held in place by gently pulling on the wire and ensure it remains connected.
4. Once wires are connected, thread the other end of the wire through an available opening at the bottom of the ChlorSync™ power supply. Using a strain relief to secure the wire is recommended.
5. Connect the wires to the four-pin connector on the PCB as per below:
 - Black wire from PoolSync™ to G (or GND)
 - Yellow or White wire from PoolSync™ to Y (or A)
 - Green wire from PoolSync™ to GRN (or B)
 - **DO NOT ATTACH THE RED WIRE. This will damage the equipment. Apply a cap to that wire.**
6. Once wires are connected, replace the connector onto the PCB header pins. Be sure to align correctly. Close the cover and restore power.

Wiring Options

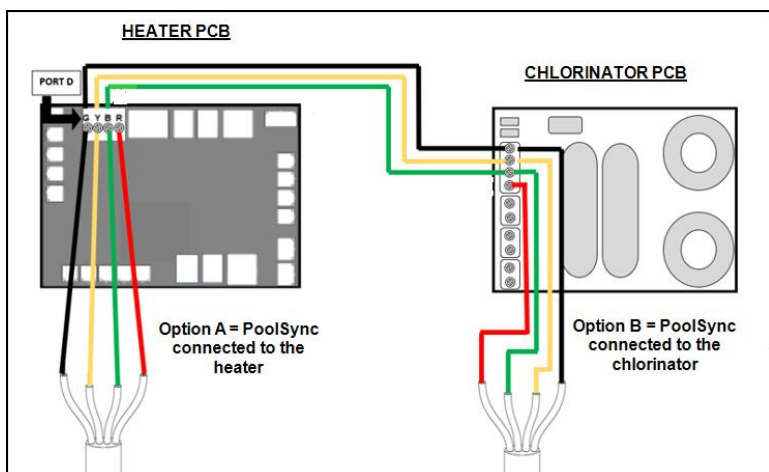





Figure 7

Downloading the PoolSync™ App

You can search the iOS App Store or Google Play Store to download the PoolSync™ app.  Follow instructions to create a new account.

Connect the PoolSync™ to the WiFi

1. Ensure Bluetooth  and WiFi  are enabled on the device.
2. Once the app is downloaded, launch the PoolSync™ app on the mobile device.
3. Tap "Log In" to access your account.
4. The app will begin scanning for currently configured devices. "Searching for PoolSync™" will be displayed.
 - If no devices are found, tap "Add New"
 - If existing devices are found, the app Dashboard will be shown. Tap the  icon on the lower right corner and click "Add New PoolSync™"
5. Follow the on-screen instructions to put the device into Setup mode. (Press the Setup button on the device to begin.)
6. Follow the onscreen instructions to connect your device to the home network.
7. When the PoolSync™ is connected to the network, you will be redirected to the Dashboard. The newly configured equipment should be visible if you are on the same WiFi network.

Discover Connected Equipment

Verify the pool equipment is connected to a power source and turned on. The PoolSync™ will automatically attempt to discover connected equipment after being setup. This process can take 30-60 seconds to complete. Swipe down on the Dashboard to refresh the page if nothing appears automatically.

To manually discover connected equipment, tap the  icon for the desired PoolSync™ Ready equipment and select "Discover Equipment" from the menu.

Mounting the PoolSync™

Once the PoolSync™ and the pool equipment are communicating and visible on your wireless device, the device can be permanently mounted.

1. Choose a suitable mounting location that is within 15' (feet) of the PoolSync™ Ready equipment. Note: To avoid any possible interference, do not mount the unit within 18" (inches) of the main electrical source power.

2. Secure vertically on a flat surface, using the two mounting tabs affixed on either side of the unit.
3. Verify once more that the PoolSync™ unit is communicating with the pool equipment via the mobile device app.

TROUBLESHOOTING

Troubleshooting

Cannot See PoolSync™ Device In Mobile App

Verify the PoolSync™ WiFi connection light  is solid or slowly fading on / off.

Verify the mobile device and PoolSync™ are connected to the same WiFi network.

Refresh the PoolSync™ app.

Reset the PoolSync™ device by pushing the  arrow button.

Lights Are Not Illuminated On The PoolSync™ Unit

Confirm equipment is receiving power.

Verify all wires from the PoolSync™ unit to the PoolSync™ Ready equipment are properly seated and securely tightened.

Reset the PoolSync™ unit by pushing the  arrow button.

Confirm the transformer is wired correctly. See the wiring diagram on the inside cover of the power center.

Restart the equipment connected to the PoolSync™ device.

LAN LED fading slowly

The PoolSync™ is only connected to the local home router. Press the  arrow button to re-connect to the Cloud.

Old PoolSync™ Still Showing In My App

Open the PoolSync™ app and tap the  icon on the Systems page.
Tap on Disable Remote Access.

Click on the  icon at the top left of the screen to complete the removal of the existing device.

REFERENCE

FCC Compliance

This device complies with part 15 of the FCC rules. Operation is subject to the following conditions:

1. This device may not cause harmful interference.
2. This device must accept any interference received, including interference that may cause undesired operation.



AUTOPILOT[®]
SALT CHLORINE GENERATORS

AquaCal[®]
SWIMMING POOL/SPA HEAT PUMPS